

CONTROL TECHNIQUES



COMMANDER

SIMPLE, RELIABLE MOTOR CONTROL

AC DRIVES, GENERAL PURPOSE

DRIVE OBSESSED

THE 6TH GENERATION OF GENERAL PURPOSE DRIVE

COMMANDER C

0.25 kW to 132 kW (0.33 HP to 200 HP)

Control Techniques has set the standards in motor control since 1973.

Our new Commander C series is based on six generations of technical knowhow and expertise. It's flexible. It's versatile.

It's up to whatever challenging application you want to throw at it. And thanks to its ground-breaking design, the new series is super quick and easy to set up too. To put it simply, it's the best performing, most reliable and energy efficient general purpose drive we've ever built.



Free 5 year warranty*

Our Commander C series is built to cope with harsh environments. In fact, it is so reliable we are confident enough to supply it with a free five-year warranty.

Now you can buy with the same confidence.

*Warranty terms and conditions apply.



FLEXIBLE MOTOR CONTROL

KEY FEATURES

Easy installation & commissioning

We've put the parameters you need on the front of the drive for easy reference.

Exceptional starting torque

Up to 180% overload for high torque applications.

Integrated functional safety

The Dual Safe Torque Off (STO) feature, certified to SIL 3/PLe safety rating and compliant with EH/IEC 6/800-5-2, prevents the motor from moving unexpectedly and can also be used to implement emergency stop without contactors.

Onboard PLC

Embedded intelligence eliminates the need for an external controller, saving both on cost and space when installing Commander C drives into a system.

Super-quick start-up

Tap in 4 key parameters (the motor rated current, RPM, voltage and power factor) and off you go.

Equipped with the latest energy saving features

The latest energy-saving technology means you get high productivity and low running costs.

Flexible connectivity

The plug in communication modules enable integration with a wide range of industrial fieldbuses

Worldwide drive centres and outstanding service

Need expert advice or support? Wherever you are in the world, we've got you covered.

CAM-DO DRIVES

All Star
LANES

A*

A*

Two

Three

CASE STUDY: BOWLING ALLEY IN BLOOMSBURY, LONDON

Commander C200 stops noisy vibrations, improving the customer experience at a London Bowling Alley.

Axxa' client All Star Lanes in Bloomsbury London, experienced noisy vibrations from their ventilation system, disturbing diners in the restaurant.

Axxa LTD worked with All Star Lanes to come up with a suitable solution, they supplied the drive and enlisted, locally based, APS Engineering to install it into the system.

Being underground, the bowling alley needs to have a constant flow of fresh air. All Star Lanes had two objectives: bring clean air in from above and extract fumes from the kitchen.

Commander delivered big benefits for the bowling alley. First, the NEMA bracket provides safe mounting onto the wall. It protects all the cables going in, ensuring the safety of the general public. Furthermore, the new drive is half the size of the original one, creating extra space.

Previously, the system ran continuously at 30 amps. Commander runs at a much lower rate of 10-15 amps, generating significant savings of 50%, resulting in a better flow of air.

The old system had too much vacuum. This caused buckling of the ducting and made it vibrate like a drum. By tuning the drive to a lower level, not only does it use less power, but it also stops the noisy vibrations going through the ducting.



“The fan motor works at a lower rpm than the old drive and has made a great difference in our restaurant area. With the new drive, the wall has stopped shaking and the venue is not noisy anymore.”

Per Lutteman, APS Engineering Director adds: “From my point of view, this was a very simple project for us. Setting the drive up was very easy. It was up and running, the way we wanted, within half an hour. It was also easy to program; All Star Lanes have excellent support on hand if they ever need it.”

Srdan Stojiljkovic
All Star Lanes Technical Manager



COMMANDER DRIVES AT THE HEART OF GENERAL PURPOSE APPLICATIONS WORLDWIDE



Conveyors

- Accurate remote speed control with fieldbus communications
- S-ramp acceleration / deceleration profiling provides smooth speed transitions minimizing machine jerk
- Overload capacity up to 180% to add stability
- Avoids early wear and tear of the equipment



Access Control

- Smooth motion with enhanced open loop control
- Small physical size allows the drive to be mounted easily in smaller control cabinets
- Highly reliable in harsh environments, providing long lasting service



Lifts, Hoists, Winches

- Adjustable mechanical brake sequencing with torque proving function – no need for an external controller
- Embedded PLC functionality can manage local I/O reducing the need for an external controller

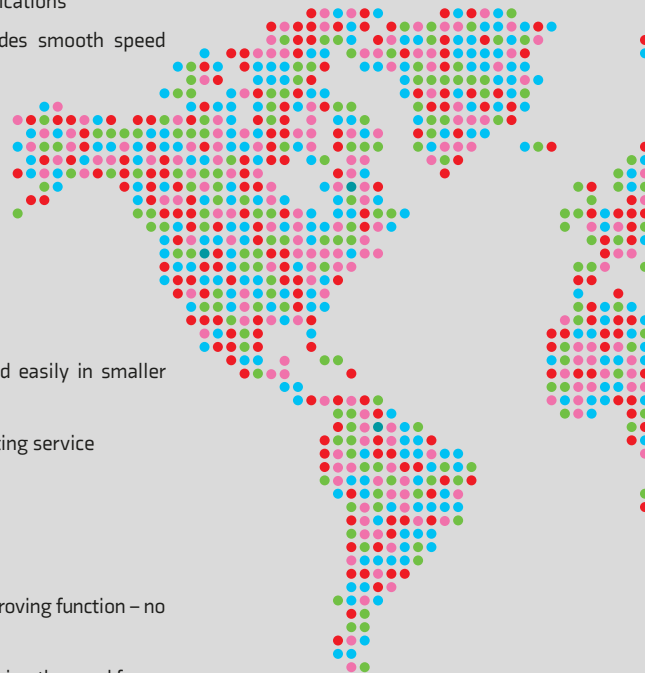

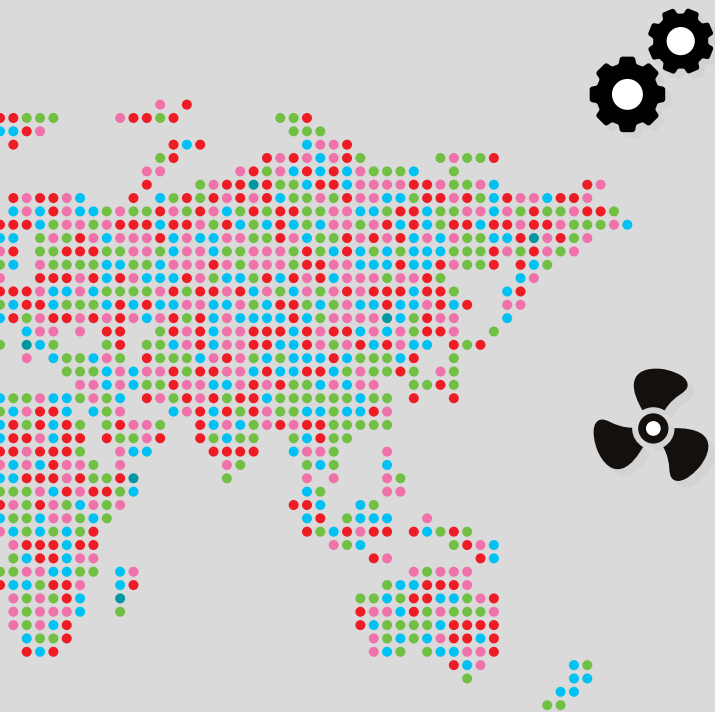

Process

(Mixers, Crushers, Agitators, Centrifuges, Extruders)

- Ease of integration to external PLC or other management systems through powerful networking options
- Conformal coating for enhanced environmental protection
- Overload capacity up to 180%
- Highly stable motor control

Pumps, Fans, Compressors

- Improved energy efficiency during periods of low demand
- On board PLC & PID functionalities make advanced control easy and efficient without the need of an external controller
- Skip Frequencies allow users to easily avoid equipment resonant frequencies, reducing high vibration levels
- Supply Loss Ride Through will keep the drive up and running through most power outages

COMMANDER C

FEATURES & ACCESSORIES

Easy motor pairing and performance control

V/Hz by default for easy set-up

- Slip compensation
- Multi-motor control
- 100% torque available to 1 Hz
- Square law V/F mode
- Dynamic V/F mode
- Auto tune (stationary and rotating)

Enhanced open loop Rotor Flux Control

- Closed current loop for greater stability
- Auto tuning (stationary and rotating)



Simple setup and configuration



Fixed LED Keypad
(as standard)



Operator Interface



Remote Keypad RTC



**IP66 (NEMA 4)
Remote Keypad (LCD)**



RS485 Cable



AI-Back-up Adaptor
(provides SD card usage for programming / cloning)



AI-Smart Adaptor
(provides SD card (supplied) usage for programming / cloning)



AI-485 24 V Adaptor
(As AI485 adaptor but including 24 V input)



Flexible connectivity

The 'SI' Interface on Commander C enables integration with a wide range of industry standard fieldbuses to allow remote control and diagnostics across different networks. Additionally, the AI-485 Adaptor option permits connection to RS485 networks using Modbus RTU.

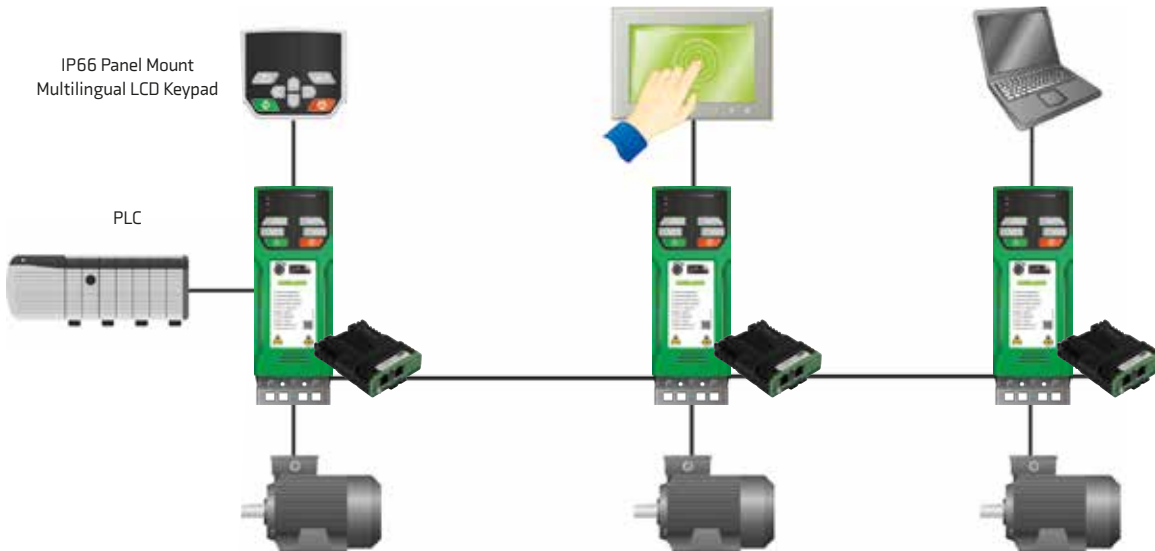

Communication options



AI-485 Adaptor



SI-EtherCAT



SI-PROFINET



SI-DeviceNet



SI-PROFIBUS



SI-CANopen



SI-Ethernet

Robust and reliable design

- PCBs conformal coated for resilience to harsh environments
- Patented air flow system cools and protects components
- Supply voltage tolerance for smooth operation during disturbances to supply
- Intelligent three speed user replaceable fan with failure detection
- Trip avoidance features take action instead of tripping out:
 - i. Load shedding reduces speed at current limits
 - ii. Supply loss ride-through keeps motor running during brown outs
- High overload capability: 180% for 3 seconds (RFC-A mode) or 150% for 60 seconds (Open loop mode)
- Ingress protection: IP20/NEMA 1 - UL Type 1 with conduit box

Embedded intelligence reduces costs

- Onboard PLC
- Built-in independent PID control

Energy saving

- Dynamic V/Hz - improves efficiency by reducing motor losses during low demand
- 98% efficient - only 2% of energy is lost during the conversion process
- Low power standby mode - drives can be idle for significant periods, saving energy
- Automatic 3-speed cooling fan - keeps energy usage & acoustics noise to a minimum by intelligently responding to load and the environment
- Square Law V/F mode - optimized for quadratic loads to reduce motor losses

Input / Output

Onboard as standard

- 3 x Analog I/O
- 5 x Digital I/O
- 1 x Relay
- 2 X STO (C300 only)



SI-I/O

- 4 x Digital I/O
- 1 x Digital input
- 3 x Analog inputs (default) / Digital inputs
- 2 x Relays





Intuitive commissioning software

For fast task based commissioning and easy maintenance **Connect** offers a familiar Windows™ interface and intuitive graphical tools to enhance data analysis.

The dynamic drive logic diagrams allow the visualisation and control of the drive in real time. The parameter browser enables viewing, editing and saving of parameters as well as importing parameter files from our legacy drives.

Advanced machine control

For more advanced applications **Machine Control Studio** provides a flexible and intuitive environment for programming. This is possible thanks to the onboard PLC that increases the drives functionality at no extra cost.

Control Techniques also provides support for customers' own function block libraries, with on-line monitoring of program variables with user defined watch windows and help for on-line change of program, in line with current PLC practice.

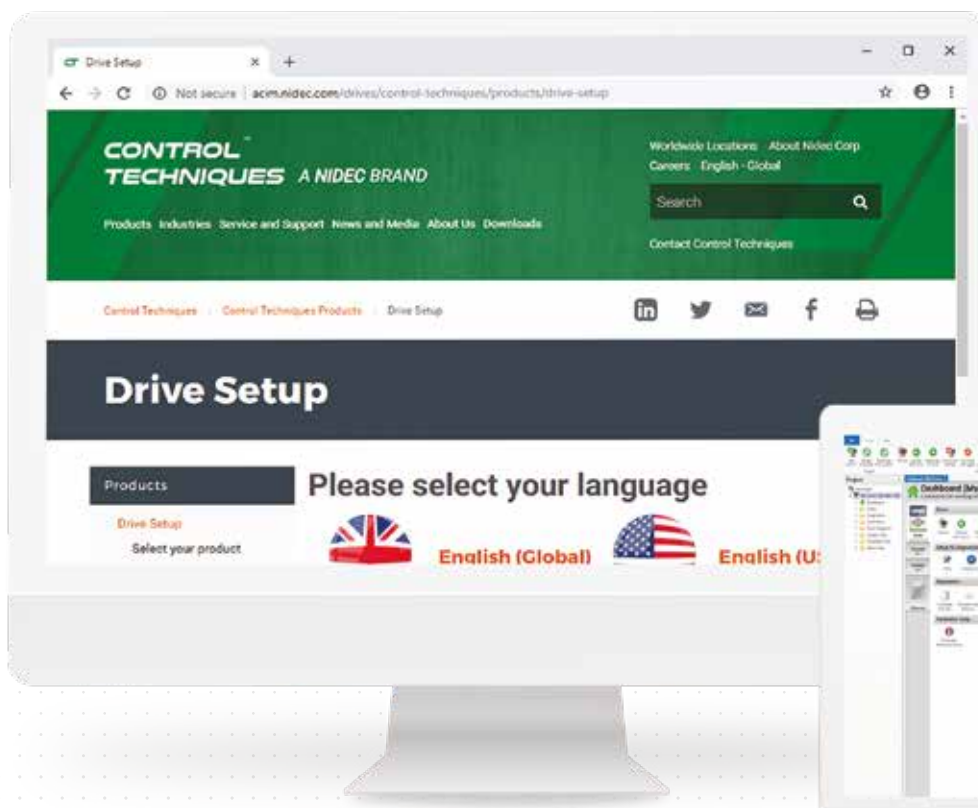

VIRTUAL DEMO: COMMANDER C DRIVE SIMULATOR

The Commander C Virtual Demo Tool provides a safe and accessible first experience with Commander C variable speed drives and allows you to get familiar with the Commander C keypad and menu structure.

This digital replica of a Commander C drive, motor and control allows you to use the virtual keypad to set-up the drive parameters for commissioning just like in a real situation. Once the key parameters have been set, the drive can be enabled and the motor shaft will spin.

To see just how easy it is to set-up the drive, visit: www.controltechniques.com/virtual-demo-tool

Diagnostics? There's an app for that



Diagnostic Tool

The Diagnostic Tool App is a fast and simple tool, which allows users to quickly solve any error codes that the drive may show.

Download from:

controltechniques.com/mobile-applications



*For Microsoft users, this mobile app operates with Windows 10 only.

Free online help: Drive-Setup.com

You'll have permanent free access to lots of web pages with useful information, like user manuals, 'how-to' videos and explainer guides.

YouTube Training

Access a series of Commander training videos, available on YouTube, visit:

www.youtube.com/controltechniques

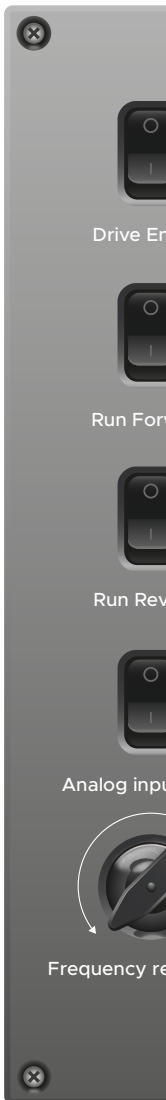

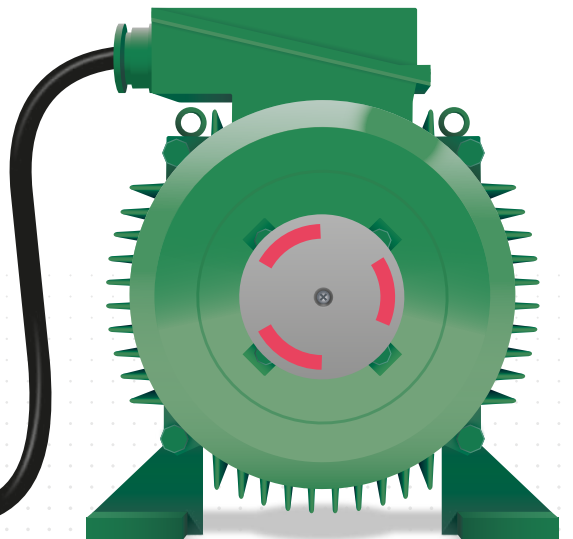
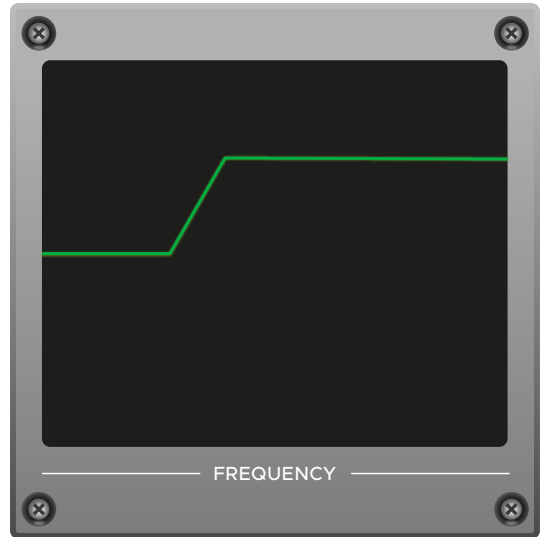

COMMANDER C

SPECIFICATIONS

Environment	
Ambient Operating Temperature	Size 1 - 4: -20°C to 40°C (-4°F to 104°F) @ 3 kHz switching freq. Operation to 60°C (140°F) with de-rating Size 5 - 9: -20°C to 40°C (-4°F to 104°F) @ 3 kHz switching freq. Operation to 55°C (131°F) with de-rating
Cooling method	Forced convection
Humidity	95 % non-condensing at 40 °C (104 °F)
Storage Temperature	Size 1 - 4: -40°C to 60°C (-40°F to 140°F) — 24 months Max. Size 5 - 9: -40°C to 55°C (-40°F to 131°F) — 24 months Max.
Altitude	De-rate the continuous output current by 1% for every 100 m (328 ft) above 1000 m (3,280 ft) to a maximum of 3000 m (9,840 ft)
Vibration	Tested in accordance with IEC 60068-2-64 and IEC 60068-2-6
Mechanical Shock	Tested in accordance with IEC 60068-2-27 and IEC 60068-2-29
Enclosure Rating	IP20, NEMA 1 conduit kits available
Electromagnetic Capability	IEC/EN 61800-3 Immunity and Emissions EN 61000-6-2: Immunity for industrial environments EN 61000-6-4: Emissions for industrial environments EN 61000-3-2: Harmonic current emissions An EMC data sheet is available on request
RoHS	Complies with the Restriction of Hazardous Substances Directive (2011/65/EU)

AC Supply Requirements	
Voltage	100 V models: 100 to 120 Vac ±10% 200 V models: 200 to 240 Vac ±10% 400 V models: 380 to 480 Vac ±10% 575 V models: 500 to 575 V +/-10% 690 V models: 500 to 690 V +/-10%
Phases	1Ø and 3Ø (Model dependent)
Maximum Supply Imbalance	2% negative phase sequence, 3% voltage imbalance between phases
Input Frequency	45 to 66 Hz
Input Displacement Power Factor	0.97
Switching Frequency	Size 1 - 4: 0.667, 1, 2, 3, 4, 6, 8, 12 & 16 kHz Size 5 - 9: 2, 3, 4, 6, 8, 12 & 16 kHz
Output Frequency Range	0 to 550 Hz
Frequency Accuracy	±0.02% of full scale
Frequency Resolution	0.01 Hz
Analog Input Resolution	Voltage mode: 11 bits (unipolar) Current mode: 11 bits
Braking	Dynamic braking transistor included, requires external resistor

Protection	
DC Bus Undervoltage Trip	100 V models: 175 Vdc 200 V models: 175 Vdc 400 V models: 330 Vdc 575 V models: 435 Vdc 690 V models: 435 Vdc
	<p>Frame sizes 1 - 4: 100 V models: 510 Vdc 200 V models: 510 Vdc 400V models: 870 Vdc</p> <p>Frame size 5 - 9: 200V models: 415 Vdc 400 V models: 830 Vdc 575 V models: 990 Vdc 690 V models: 1190 Vdc</p>
DC Bus Overvoltage Trip	
Drive Overload Trip	Programmable: Default settings: 180% for 3s, 150% for 60s
Instantaneous Overcurrent Trip	220% of rated motor current
Phase Loss Trip	DC bus ripple threshold exceeded
Over-temperature Trip	Drive heatsink temperature exceeds 95°C (203°F)
Short Circuit Trip	Protects against output phase-to-phase fault
Ground Fault Trip	Protects against output phase-to-ground fault
Motor Thermal Trip	Electronically protects the motor from overheating due to loading conditions

Approval & Listings	
UL, cUL	UL file NMMS/8: E171230
CE	CE approval
EU	These products comply with the Restriction of Hazardous Substances Directive (2011/65/EU), the Low Voltage Directive (2014/35/EU) and the Electromagnetic Compatibility Directive, (2014/30/EU).
RCM	RCM Registered supplier No. 12003815281
ISO	Manufacturing facilities comply with ISO 9001:2015 and ISO 14001
TÜV	<p>C300 models only: The Safe Torque Off (STO) function may be used as a safety component of a machine.</p> <p>Type examination certificates by TÜV Rheinland: Frame sizes 1 - 4: No. 01/205/5383.03/18 Frame sizes 5 - 9: No. 01/205/5387.02/18</p> <p>Functional safety parameters: EN ISO 13849-1 - Cat 4, PL_e EN61800-5-2/EN62061/IEC 61508 - SIL 3 UL functional safety approval: FSPC E171230</p>
EAC	RU C-GB.HA10.B.01062

COMMANDER C

TERMINAL DIAGRAM

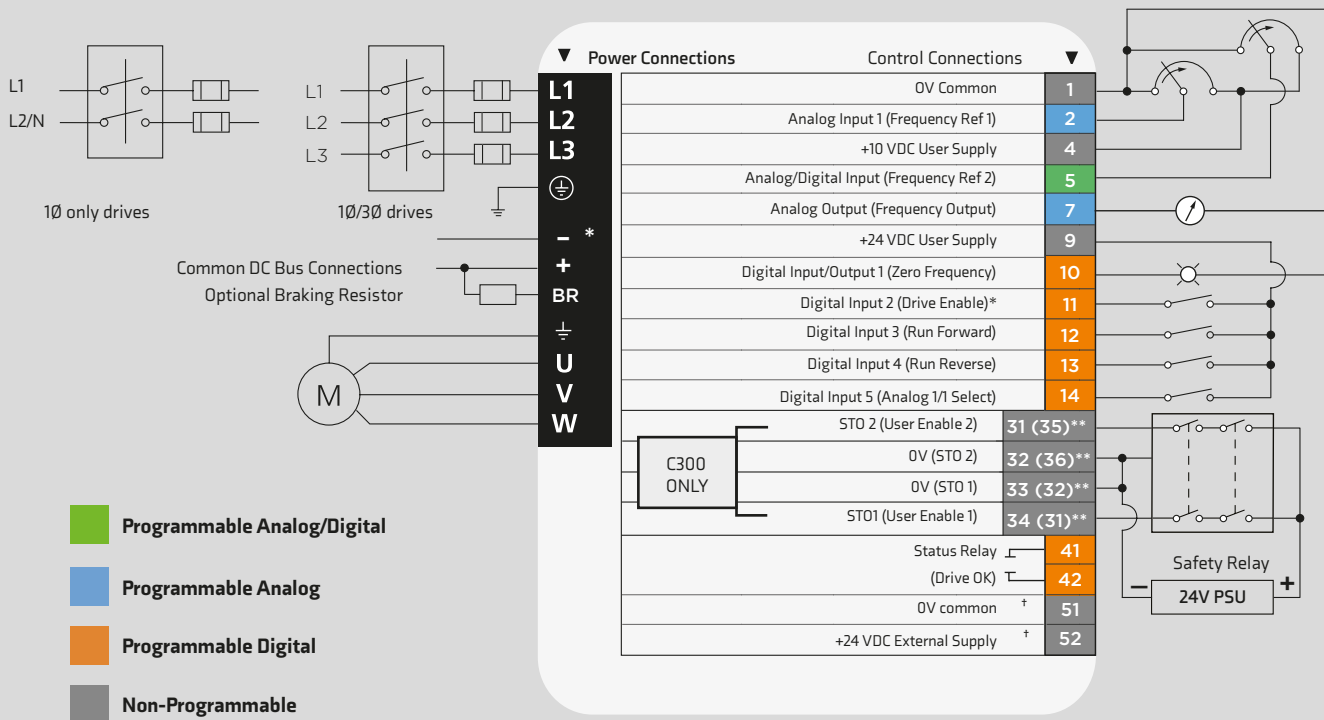

Pin#	Default Function	Type/Description	Notes
1	0V Common	Common for external analog signals	
2	Frequency reference 1	Single ended analog input 11 bit	0 to +10 Vdc, 0-20 mA or 4-20 mA or 20-4 mA or 20-0 mA
4	+10 Vdc user supply	Reference supply	5 mA Output current
5	Frequency reference 2	Single ended analog input 11 bit or digital input	0 to +10 Vdc or 0 to +24 Vdc
7	Output frequency	Single ended analog output	0 to +10 Vdc
9	+24 Vdc user supply	Digital I/O supply	100 mA
10	At zero frequency	Digital I/O 1	0 to +24 Vdc
11	Enable*	Digital input 2	0 to +24 Vdc
12	Run forward	Digital input 3	0 to +24 Vdc
13	Run reverse	Digital input 4	0 to +24 Vdc
14	Analog input 1/2 select	Digital input 5	0 to +24 Vdc
31(35)**	Safe Torque Off/Drive enable	STO 2	0 to +24 Vdc
32(36)**	0V STO 2	0V STO 2	0V common for STO 2
33(32)**	0V STO 1	0V STO 1	0V common for STO 1
34(31)**	Safe Torque Off/Drive enable	STO 1	0 to +24 Vdc
41	Status relay (drive OK)	Normally open contact	2 A, 240 Vac, 0.5 A, 30 Vdc inductive load
42			
51 †	0V common	Common for backup supply	
52 †	+24 Vdc external supply	Backup control supply	24 Vdc, 40 W

Notes

* C300 uses STO, so terminal 11 is unassigned

** Frames 1 to 4 (Frames 5 to 9) - different terminals by frame size

Frames 1 to 4 - the 0V terminals on the Safe Torque Off are isolated from each other and the 0V common

Frames 5 to 9 - the 0V terminals on the Safe Torque Off are not isolated from each other and the 0V common

The Safe Torque Off / Drive enable terminal is a positive logic only input

† Terminal 51 and 52 must be connected to an external 24 V power supply if backup is required (frame sizes 6-9 only)

COMMANDER C

ORDERING GUIDE

How to select a drive

Electrical Considerations

- What is the supply voltage?
- Single or three phase input power?
- What is the motor rating?
- Continuous current – FLA (Full Load Amps)
- Select the drive based on motor Amps rather than power rating

Drive Mechanical Mounting

- Panel mounting – as standard
- Wall mounting – UL conduit kits are available
- Through panel mounting – frames 5 and up



Frame size	Dimensions H x W x D mm (in)	Weight kg (lb)
1	160 x 75 x 130 (6.3 x 2.95 x 5.1)	0.75 (1.65)
2	205 x 75 x 150 (8.07 x 2.95 x 5.9)	1.3 (3.0)
3	226 x 90 x 160 (8.9 x 3.54 x 6.3)	1.5 (3.3)
4	277 x 115 x 175 (10.9 x 4.5 x 6.9)	3.13 (6.9)
5	391 x 143 x 200 (15.39 x 5.63 x 7.87)	7.4 (16.3)
6	391 x 210 x 227 (15.39 x 8.27 x 8.94)	14 (30.9)
7	557 x 270 x 280 (21.93 x 10.63 x 11.02)	28 (61.70)
8	804 x 310 x 290 (31.65 x 12.21 x 11.42)	52 (114.6)
9E	1069 x 310 x 290 (42.09 x 12.21 x 11.42)	46 (101.4)
9A	1108 x 310 x 290 (43.62 x 12.21 x 11.42)	66.5 (146.6)

COMMANDER C

PART NUMBERS

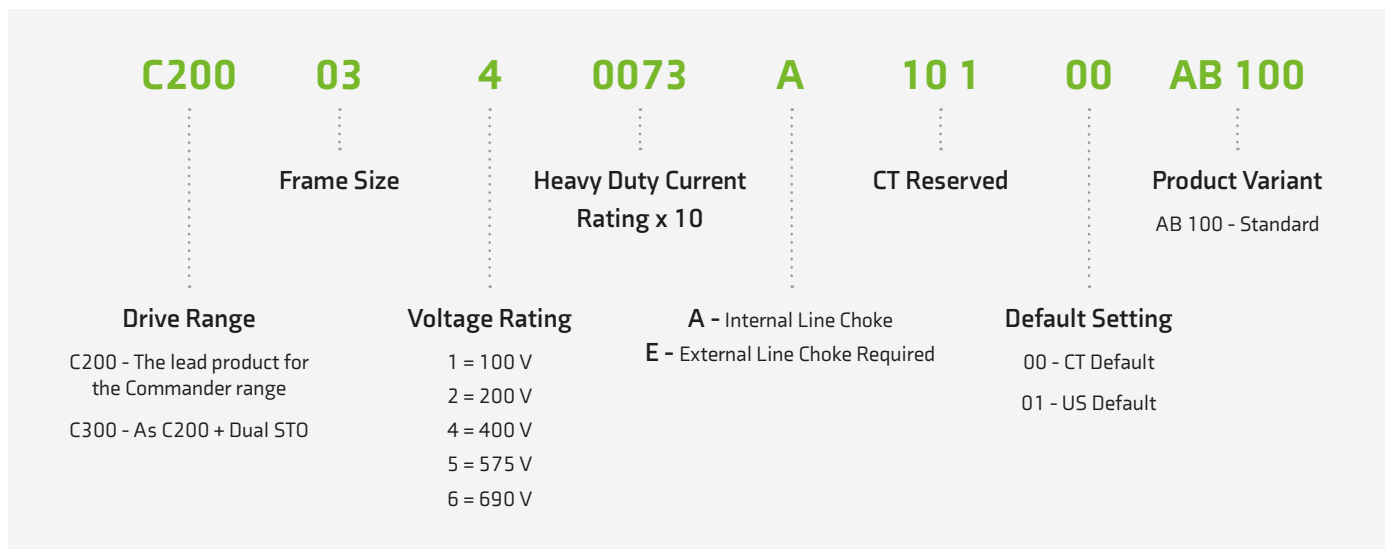

Note: For the STO variants just replace the C200 digits at the start of the part number with C300.

100/200 VAC +/- 10%

Product Code	Size	Input Phases	Heavy Duty			Normal Duty		
			Max Cont. Current (A)	Motor Power (kW)	Motor Power (HP)	Max Cont. Current (A)	Motor Power (kW)	Motor Power (HP)
C200-01100017A10100AB100	01	1	1.7	0.25	0.33			
C200-01100024A10100AB100	01	1	2.4	0.25	0.5			
C200-02100042A10100AB100	02	1	4.2	0.75	1			
C200-02100056A10100AB100	02	1	5.6	1.1	1.5			

For Normal Duty applications, use Heavy Duty ratings.

200/240 VAC +/-10%

Product Code	Size	Input Phases	Heavy Duty			Normal Duty		
			Max Cont. Current (A)	Motor Power (kW)	Motor Power (HP)	Max Cont. Current (A)	Motor Power (kW)	Motor Power (HP)
C200-01200024A10100AB100	1	1	2.4	0.37	0.5			
C200-01200033A10100AB100	1	1	3.3	0.55	0.75			
C200-01200042A10100AB100	1	1	4.2	0.75	1			
C200-02200024A10100AB100	2	1 3	2.4	0.37	0.5			
C200-02200033A10100AB100	2	1 3	3.3	0.55	0.75			
C200-02200042A10100AB100	2	1 3	4.2	0.75	1			
C200-02200056A10100AB100	2	1 3	5.6	1.1	1.5			
C200-02200075A10100AB100	2	1 3	7.5	1.5	2			
C200-03200100A10100AB100	3	1 3	10	2.2	3			
C200-04200133A10100AB100	4	1 3	13.3	3	3			
C200-04200176A10100AB100	4	3	17.6	4	5			
C200-05200250A10100AB100	5	3	25	5.5	7.5	30	7.5	10
C200-06200330A10100AB100	6	3	33	7.5	10	50	11	15
C200-06200440A10100AB100	6	3	44	11	15	58	15	20
C200-07200610A10100AB100	7	3	61	15	20	75	18.5	25
C200-07200750A10100AB100	7	3	75	18.5	25	94	22	30
C200-07200830A10100AB100	7	3	83	22	30	117	30	40
C200-08201160A10100AB100	8	3	116	30	40	149	37	50
C200-08201320A10100AB100	8	3	132	37	50	180	45	60
C200-09201760A10100AB100	9	3	176	45	60	216	55	75
C200-09202190A10100AB100	9	3	219	55	75	266	75	100
C200-09201760E10100AB100	9	3	176	45	60	216	55	75
C200-09202190E10100AB100	9	3	219	55	75	266	75	100
C200-02200056A10100AB100	2	1 3	5.6	1.1	1.5			
C200-02200075A10100AB100	2	1 3	7.5	1.5	2			
C200-03200100A10100AB100	3	1 3	10	2.2	3			
C200-04200133A10100AB100	4	1 3	13.3	3	3			
C200-04200176A10100AB100	4	3	17.6	4	5			
C200-05200250A10100AB100	5	3	25	5.5	7.5	30	7.5	10
C200-06200330A10100AB100	6	3	33	7.5	10	50	11	15
C200-06200440A10100AB100	6	3	44	11	15	58	15	20

For Normal Duty applications, use Heavy Duty ratings.

For Normal Duty applications, use Heavy Duty ratings.

C200-07200610A10100AB100	7	3	61	15	20	75	18.5	25
C200-07200750A10100AB100	7	3	75	18.5	25	94	22	30
C200-07200830A10100AB100	7	3	83	22	30	117	30	40
C200-08201160A10100AB100	8	3	116	30	40	149	37	50
C200-08201320A10100AB100	8	3	132	37	50	180	45	60
C200-09201760A10100AB100	9	3	176	45	60	216	55	75
C200-09202190A10100AB100	9	3	219	55	75	266	75	100
C200-09201760E10100AB100	9	3	176	45	60	216	55	75
C200-09202190E10100AB100	9	3	219	55	75	266	75	100

380/480 VAC +/-10%

Product Code	Size	Input Phases	Heavy Duty			Normal Duty		
			Max Cont. Current (A)	Motor Power (kW)	Motor Power (HP)	Max Cont. Current (A)	Motor Power (kW)	Motor Power (HP)
C200-02400018A10100AB100	2	3	1.8	0.55	0.75			
C200-02400023A10100AB100	2	3	2.3	0.75	1			
C200-02400032A10100AB100	2	3	3.2	1.1	1.5			
C200-02400041A10100AB100	2	3	4.1	1.5	2			
C200-03400056A10100AB100	3	3	5.6	2.2	3			
C200-03400073A10100AB100	3	3	7.3	3	3			
C200-03400094A10100AB100	3	3	9.4	4	5			
C200-04400135A10100AB100	4	3	13.5	5.5	7.5			
C200-04400170A10100AB100	4	3	17	7.5	10			
C200-05400270A10100AB100	5	3	27	11	20	30	15	20
C200-05400300A10100AB100	5	3	30	15	20	30	15	20
C200-06400350A10100AB100	6	3	35	15	25	38	18.5	25
C200-06400420A10100AB100	6	3	42	18.5	30	48	22	30
C200-06400470A10100AB100	6	3	47	22	30	63	30	40
C200-07400660A10100AB100	7	3	66	30	50	79	37	50
C200-07400770A10100AB100	7	3	77	37	60	94	45	60
C200-07401000A10100AB100	7	3	100	45	75	112	55	75
C200-08401340A10100AB100	8	3	134	55	100	155	75	100
C200-08401570A10100AB100	8	3	157	75	125	184	90	125

For Normal Duty applications, use Heavy Duty ratings.

C200-09402000A10100AB100	9	3	200	90	150	221	110	150
C200-09402240A10100AB100	9	3	224	110	150	266	132	200
C200-09402000E10100AB100	9	3	200	90	150	221	110	150
C200-09402240E10100AB100	9	3	224	110	150	266	132	200

500/575 VAC +/-10%

Product Code	Size	Input Phases	Heavy Duty			Normal Duty		
			Max Cont. Current (A)	Motor Power (kW)	Motor Power (HP)	Max Cont. Current (A)	Motor Power (kW)	Motor Power (HP)
C200-05500040A10100AB100	5	3	4	2.2	3	6.1	4	5
C200-05500069A10100AB100	5	3	6.9	4	5	10	5.5	7.5
C200-06500100A10100AB100	6	3	10	5.5	7.5	12	7.5	10
C200-06500150A10100AB100	6	3	15	7.5	10	17	11	15
C200-06500190A10100AB100	6	3	19	11	15	22	15	20
C200-06500230A10100AB100	6	3	23	15	20	27	18.5	25
C200-06500290A10100AB100	6	3	29	18.5	25	34	22	30
C200-06500350A10100AB100	6	3	35	22	30	43	30	40
C200-07500440A10100AB100	7	3	44	30	40	53	37	50
C200-07500550A10100AB100	7	3	55	37	50	73	45	60
C200-08500630A10100AB100	8	3	63	45	60	86	55	75
C200-08500860A10100AB100	8	3	86	55	75	108	75	100
C200-09501040A10100AB100	9	3	104	75	100	125	90	125
C200-09501310A10100AB100	9	3	131	90	125	150	110	150
C200-09501040E10100AB100	9	3	104	75	100	125	90	125
C200-09501310E10100AB100	9	3	131	90	125	150	110	150





500/690 VAC +/-10%

Product Code	Size	Input Phases	Heavy Duty			Normal Duty		
			Max Cont. Current (A)	Motor Power (kW)	Motor Power (HP)	Max Cont. Current (A)	Motor Power (kW)	Motor Power (HP)
C200-07600240A10100AB100	7	3	24	18.5	25	30	22	30
C200-07600290A10100AB100	7	3	29	22	30	36	30	40
C200-07600380A10100AB100	7	3	38	30	40	46	37	50
C200-07600440A10100AB100	7	3	44	37	50	52	45	60
C200-07600540A10100AB100	7	3	54	45	60	73	55	75
C200-08600630A10100AB100	8	3	63	55	75	86	75	100
C200-08600860A10100AB100	8	3	86	75	100	108	90	125
C200-09601040A10100AB100	9	3	104	90	125	125	110	150
C200-09601310A10100AB100	9	3	131	110	150	150	132	175
C200-09601040E10100AB100	9	3	104	90	125	125	110	150
C200-09601310E10100AB100	9	3	131	110	150	150	132	175





ACCESSORIES

ORDERING GUIDE



Optional keypad Order code

Remote Keypad		82500000000001
Remote keypad RTC		82400000019600

Optional accessories Order code

AI-Back-up Adaptor		82500000000004
AI-485 Adaptor		82500000000003
AI-Smart Adaptor		82500000018500
RS485 cable		4500-0096
AI-485 24 V Adaptor		82500000019700

SI option modules Order code (available from frame size 2 and upwards)

SI-EtherCAT		82400000018000
SI-PROFIBUS		82400000019600
SI-Ethernet		82400000017500
SI-DeviceNet		82400000017700
SI-CANopen		82400000017600
SI-PROFINET		82500000018200
SI-I/O		82400000017800

Through hole IP65 kit*

Frame Size	Order Code
5	3470-0067
6	3470-0055
7	3470-0079
8	3470-0083
9A	3470-0119
9E	3470-0105

Finger-guard grommet

Frame Size	Order Code
9A / 9E	3470-0107

Line reactor

Frame Size	Order Code
9E (400 V)	7022-0063

Lifting tool

Frame Size	Order Code
9A	7778-0045
9E	7778-0016

Fan replacement kit

Frame Size	Order Code
1	3470-0092
2	3470-0095
3	3470-0099
4	3470-0103

*IP65 / UL TYPE 12 rating is achieved on the rear of the drive when through panel mounted using the following kits.

**These mounting brackets ensure the drive can be mounted on existing Commander SK installations.

* Commander C built-in EMC filter complies with EN/IEC 61800-3. External EMC filters are required for compliance with EN/IEC 61000-6-4 as per the table below.

UL Type 1 Conduit kit

Frame Size	Order Code
1	3470-0091
2	3470-0094
3	3470-0098
4	3470-0102
5	3470-0069
6	3470-0059
7	3470-0080
8 / 9A	3470-0088
9E	3470-0115

Retrofit kit

Frame Size	Order Code
3	3470-0097
4	3470-0101
5	3470-0066
6	3470-0074
7	3470-0078
8	3470-0087
9A / 9E	3470-0118

Optional external EMC filters***

Frame Size	Voltage	Phases	Type	Order code
1	All	1	Standard	4200-1000
	All	1	Low leakage	4200-1001
2	100V	1	Standard	4200-2000
		1	Standard	4200-2001
		1	Low leakage	4200-2002
		3	Standard	4200-2003
	200V	3	Low leakage	4200-2004
		3	Standard	4200-2005
		3	Low leakage	4200-2006
		1	Standard	4200-3000
3	200V	1	Low leakage	4200-3001
		3	Standard	4200-3004
		3	Low leakage	4200-3005
	400V	3	Standard	4200-3008
		3	Low leakage	4200-3009
		1	Standard	4200-4000
4	200V	1	Low leakage	4200-4001
		3	Standard	4200-4002
		3	Low leakage	4200-4003
	400V	3	Standard	4200-4004
		3	Low leakage	4200-4005
		200V	3	Standard
5	400V	3	Standard	4200-0402
	200V	3	Standard	4200-2300
6	400V	3	Standard	4200-4800
	200V & 400V	3	Standard	4200-1132
8	200V & 400V	3	Standard	4200-1972
9	200V & 400V	3	Standard	4200-3021

DRIVE OBSESSED



Control Techniques has been designing and manufacturing the best variable speed drives in the world since 1973.

Our customers reward our commitment to building drives that outperform the market. They trust us to deliver on time every time with our trademark outstanding service.

More than 45 years later, we're still in pursuit of the best motor control, reliability and energy efficiency you can build into a drive. That's what we promise to deliver, today and always.

1.4K+

Employees

70

Countries

#1 FOR ADVANCED MOTOR AND DRIVE TECHNOLOGY



Nidec Corporation is a global manufacturer of electric motors and drives.

Nidec was set up in 1973. The company made small precision AC motors and had four employees. Today, it's a global corporation that develops, builds and installs cutting-edge drives, motors and control systems in over 70 countries with a workforce of more than 110,000.

You'll find its innovations in thousands of industrial plants, IoT products, home appliances, cars, robotics, mobile phones, haptic devices, medical apparatus and IT equipment all over the world.

109K

Employees

\$14.6B

Group Turnover

70+

Countries

330+

Companies



CONTROL TECHNIQUES IS YOUR GLOBAL DRIVES SPECIALIST.

With operations in over 70 countries, we're open for business wherever you are in the world.

For more information, or to find your local drive centre representatives, visit:

www.controltechniques.com

Connect with us



©2020 Nidec Control Techniques Limited. The information contained in this brochure is for guidance only and does not form part of any contract. The accuracy cannot be guaranteed as Nidec Control Techniques Ltd have an ongoing process of development and reserve the right to change the specification of their products without notice.

Nidec Control Techniques Limited. Registered Office: The Gro, Newtown, Powys SY16 3BE.

Registered in England and Wales. Company Reg. No. 01236886.

P.N. 0778-0509-05 11/20

