

AL PRODUCTEN

2021

Altube kabelbuizen

- 1 kabelbuis 30 mm (L=6 meter)
- 2 kabelbuis 60 mm (L=6 meter)
- 4 kabelbuis met kabeidoorvoer
- 5 bocht 45°
- 6 bocht 90°
- 7 open bocht 90° R=125 mm
open bocht 90° R=270 mm
- 8 koppeling
- 9 koppeling met kabeidoorvoer
- 10 T-stuk
- 11 bevestiging voor C-vorm tot 15 mm, vast
bevestiging voor C-vorm tot 30 mm, vast
- 12 bevestiging voor C-vorm tot 15 mm, draaibaar
bevestiging voor C-vorm tot 30 mm, draaibaar
- 13 bevestiging voor koker 20 x 60 mm, vast
- 14 bevestiging voor koker 20 x 60 mm, draaibaar
- 15 vloerbevestiging
- 16 grondhoek
- 17 vloerplaat T-profiel
- 18 montageplaat 165 x 175 mm, met buisklem
montageplaat 175 x 260 mm, met buisklem
montageplaat 270 x 380 mm, met buisklem
- 19 montage-unit gesloten, L=325 mm
montage-unit gesloten, L=400 mm
montage-unit gesloten, L=500 mm
montage-unit gesloten, L=600 mm
montage-unit open, L=360 mm
- 20 buisbeugel
- 21 kabeluitgang, L=260 mm
kabeluitgang, L=360 mm
kabeluitgang, L=460 mm
kabeluitgang, L=560 mm
kabeluitgang, L=660 mm
kabeluitgang, L=860 mm
- 22 U-bout
- 23 buisklem 9 mm
buisklem 14 mm
- 24 eindkap open
- 25 eindkap gesloten
- 26 beschermstrip 5 x 10 mm
beschermstrip 10 x 16 mm
- 27 naamplaatouder
- 28 buisklem met profiel
- 29 waarschuwingsschild (sticker)
- 30 draadpendelbevestiging M8/M10, electrolytisch verzinkt.
- 31 pijpbeugel

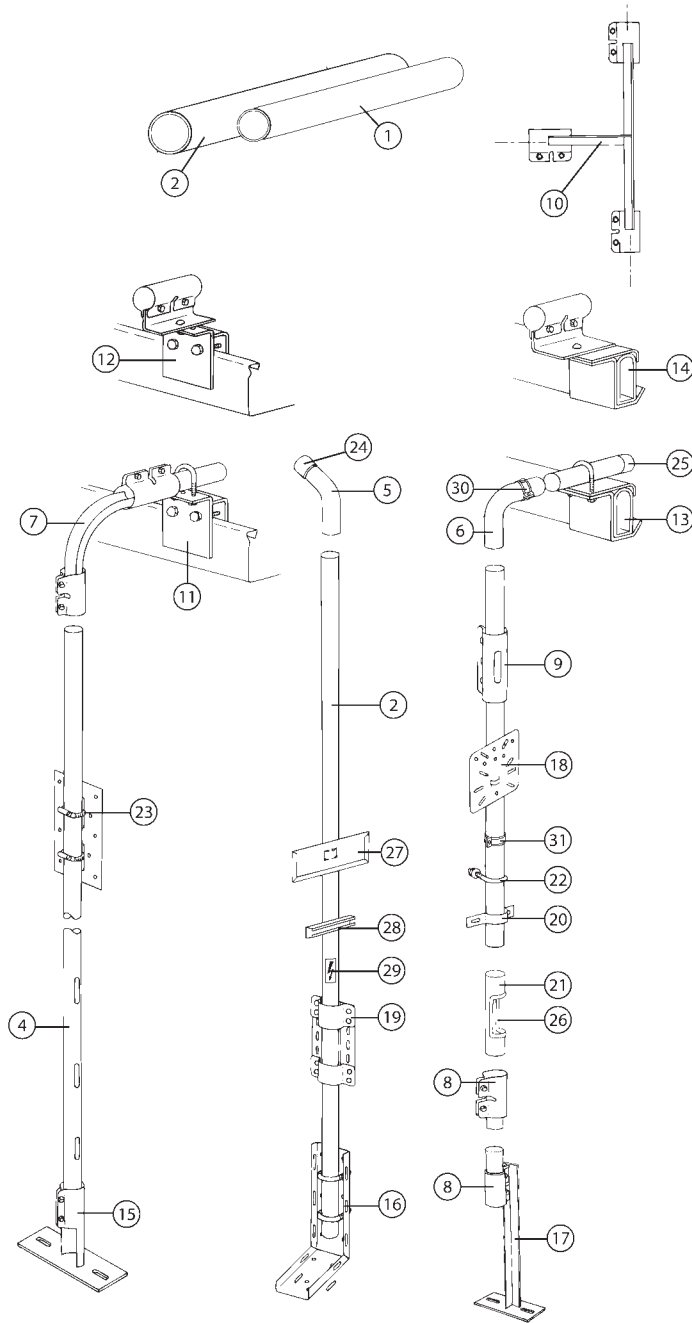

Uitvoering

- VB30, VB60 : volbad thermisch verzinkt volgens EN ISO 1461
- R2B30, R2B60: roestvast staal A2 (AISI 304).

Op aanvraag leverbaar

- Verzinkte poedergecoate uitvoering.
- R4B30, R4B60: roestvast staal A4 (AISI 316).

Altube kabelbuizen

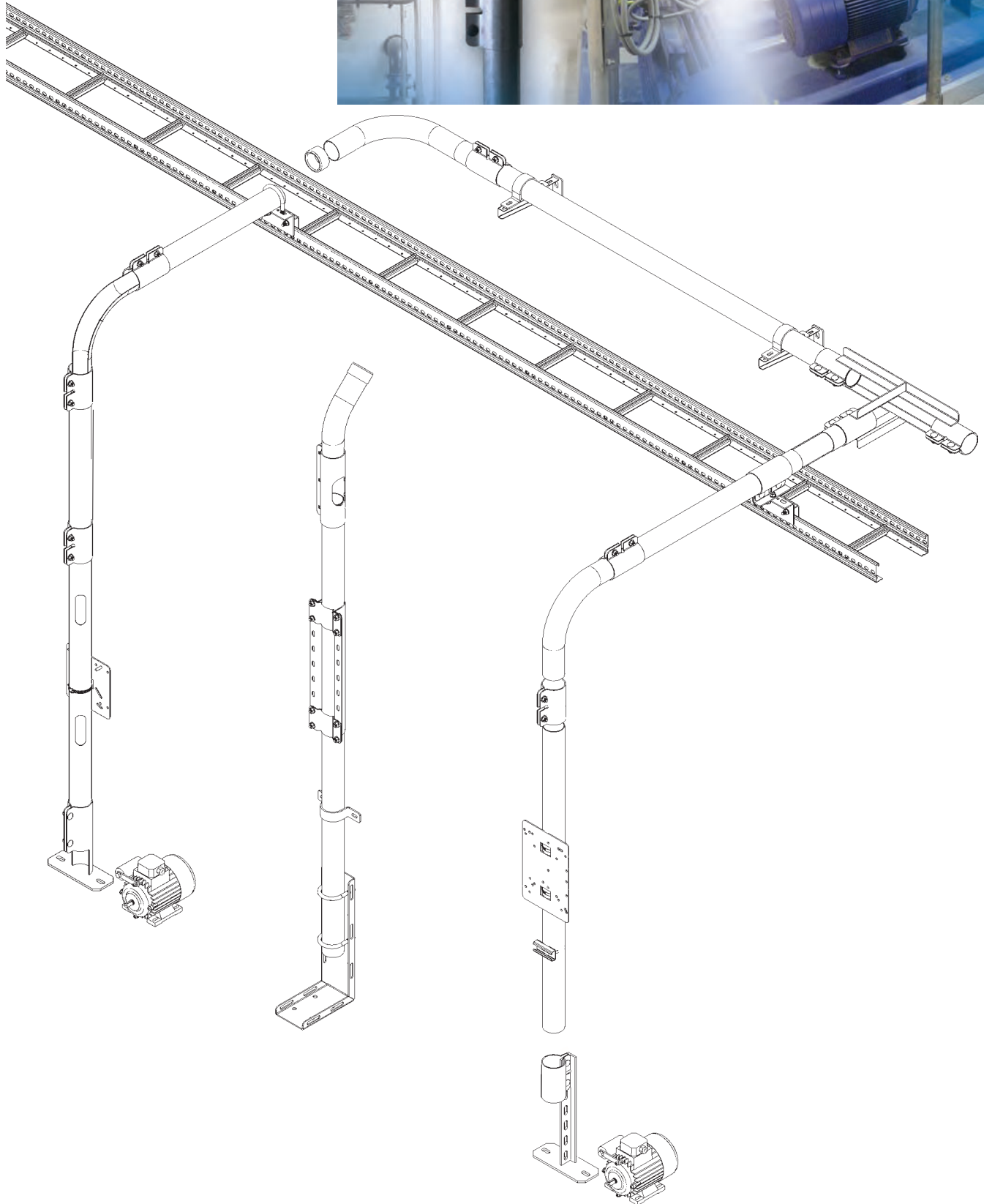

Altube
kabelbuizen

Volbad thermisch verzinkte kabelbuizen

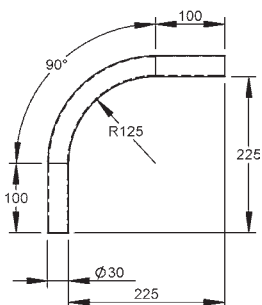
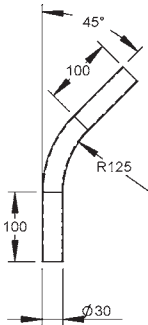
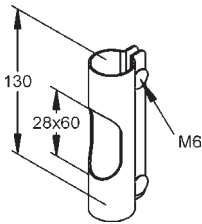
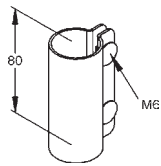
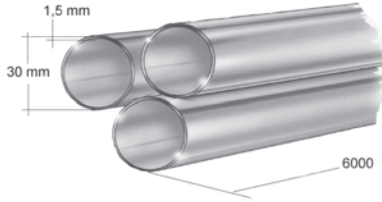

NIEDAX Typenummer	Afmetingen mm H x B	Artikel Nummer		kg stuk/m	VPE	Korting groep
----------------------	---------------------------	-------------------	--	--------------	-----	------------------

V Kabelbuis VB 30

lengte 6 meter

Kabelbuis	30	57001		1,19	6 m	HA
-----------	----	-------	--	------	-----	----

V Koppeling VB 30

Koppeling	30	57107		0,12	p/stuk	HA
-----------	----	-------	--	------	--------	----

V Koppeling VB 30, met kabeldoorvoer

Koppeling	30	57108		0,17	p/stuk	HA
-----------	----	-------	--	------	--------	----

V Bocht 45° VB 30

Bocht 45°	30	57102		0,35	p/stuk	HA
-----------	----	-------	--	------	--------	----

V Bocht 90° VB 30

Bocht 90°	30	57103		0,35	stuk	HA
-----------	----	-------	--	------	------	----

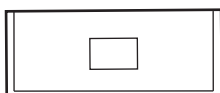
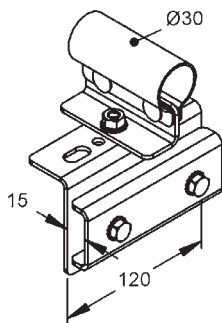
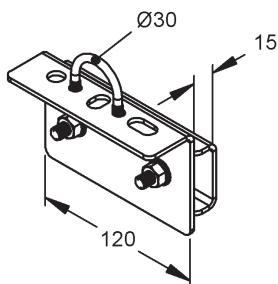
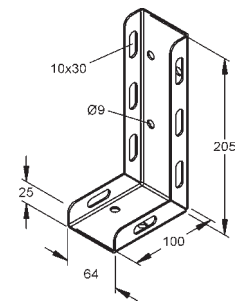
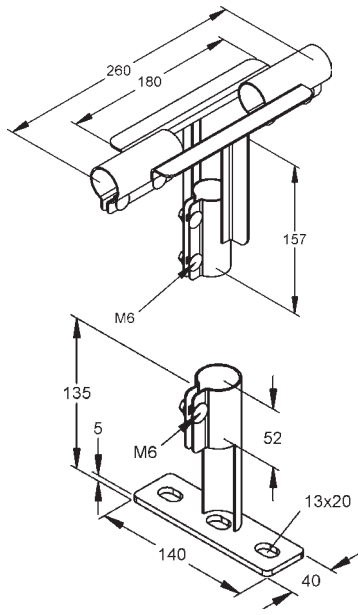

NIEDAX Typenummer	Afmetingen mm H x B	Artikel Nummer	kg stuk	VPE	Korting groep
----------------------	---------------------------	-------------------	------------	-----	------------------

V T-Stuk VB 30

T-Stuk	30	57106	0,67	p/stuk	HA
--------	----	-------	------	--------	----

V Vloerbevestiging VB 30

Vloerbevestiging	30	57114	0,36	p/stuk	HA
------------------	----	-------	------	--------	----

V Grondhoek VB 30 (U-bout niet inbegrepen)

Grondhoek	30	57115	0,48	p/stuk	HA
-----------	----	-------	------	--------	----

V Bevestiging VB 30 voor C-vorm tot 15 mm, vast

Bevestiging vast	30	57150	0,55	p/stuk	HA
------------------	----	-------	------	--------	----

V Bevestiging VB 30 voor C-vorm tot 15 mm, draaibaar

Bevest. draaibaar	30	57152	1,31	p/stuk	HA
-------------------	----	-------	------	--------	----

R2 Naamplaathouder Houder voor alle buistypen. excl. buisklem

Naamplaathouder	R2B30/60/90	69134	0,24	p/stuk	HA
-----------------	-------------	-------	------	--------	----

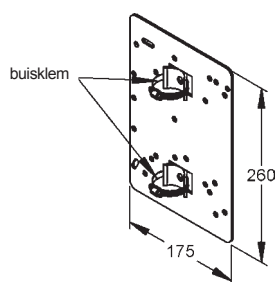
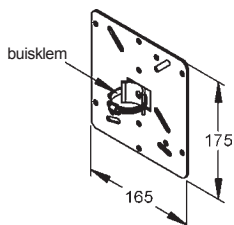
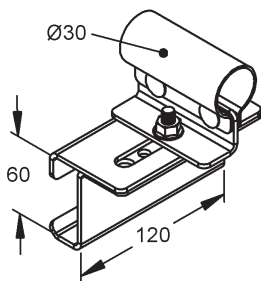
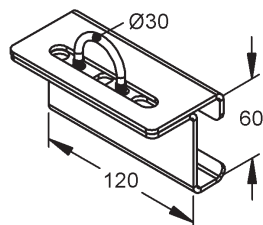
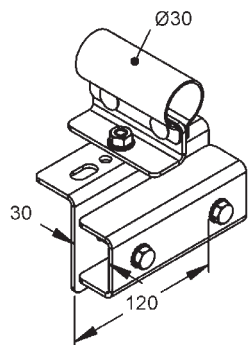
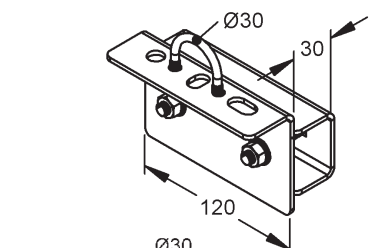

NIEDAX Typenummer	Afmetingen mm H x B	Artikel Nummer		kg stuk	VPE	Korting groep
----------------------	---------------------------	-------------------	--	------------	-----	------------------

V Bevestiging VB 30 voor C-vorm tot 30 mm, vast

Bevestiging vast	30	57154		0,64	p/stuk	HA
------------------	----	--------------	--	------	--------	----

V Bevestiging VB 30 voor C-vorm tot 30 mm, draaibaar

Bevest. draaibaar	30	57156		1,41	p/stuk	HA
-------------------	----	--------------	--	------	--------	----

V Bevestiging VB 30 voor koker 20x60 mm, vast

Bev. Koker vast	30	57158		0,88	p/stuk	HA
-----------------	----	--------------	--	------	--------	----

V Bevestiging VB 30 voor koker 20x60 mm, draaibaar

Bev. Koker draai.	30	57160		0,8	p/stuk	HA
-------------------	----	--------------	--	-----	--------	----

V Montageplaat VB 30, incl. 1 buisklem

Montageplaat	30	57116		0,69	p/stuk	HA
--------------	----	--------------	--	------	--------	----

V Montageplaat VB 30, incl. 2 buisklemmen

Montageplaat	30	57117		1,13	p/stuk	HA
--------------	----	--------------	--	------	--------	----

NIEDAX Typenummer	Afmetingen mm H x B	Artikel Nummer	kg stuk	VPE	Korting groep
----------------------	---------------------------	-------------------	------------	-----	------------------

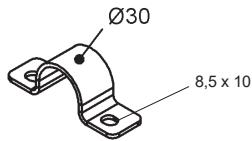

V Buisbeugel VB 30

Buisbeugel	30	57121	0,06	20 stuk	HA
------------	----	-------	------	---------	----

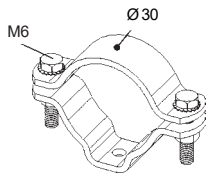

V Muur - draadpendelbevestiging VB 30

Pijpbeugel	30	57144	0,1	p/stuk	HA
------------	----	-------	-----	--------	----

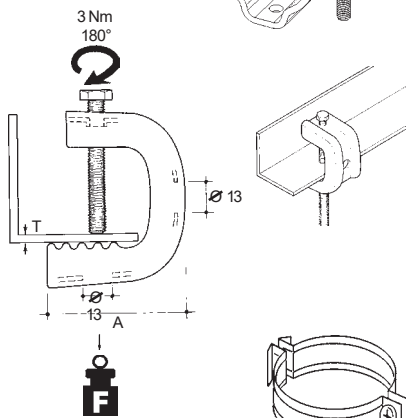

V Balkklem

	Flensdikte				
Balkklem C 20	4-20 mm	45101	0,11	p/stuk	HA
Balkklem C 30	17-30 mm	45102	0,13	p/stuk	HA
Balkklem C 45	30-45 mm	45103	0,16	p/stuk	HA

Altube
kabelbuizen

V Pijpbeugel VB 30

VF CR 28-3	26,9 - 31,8	45115	0,05	p/stuk	HA
------------	-------------	-------	------	--------	----

E Draadpendelbevestiging EB 30

Draadpendelbev.	M8+M10	57146	0,06	p/stuk	HA
-----------------	--------	-------	------	--------	----

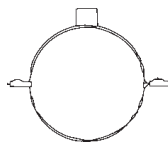

V U-bout VB 30 met 2 x ring en moer

U-bout	30	57136	0,03	20 stuk	HA
--------	----	-------	------	---------	----

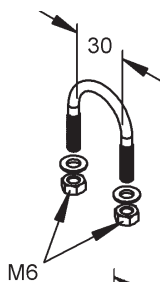

V Buiskleem VB 30 met profiel

Buiskleem	30	57131	0,08	p/stuk	HA
-----------	----	-------	------	--------	----

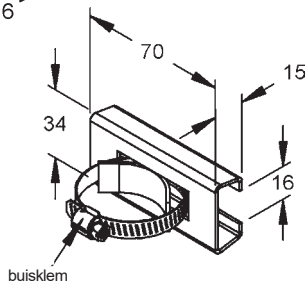

K Eindkap VB 30, open, geel

Eindkap	30	57133	0,01	25 stuk	HA
---------	----	-------	------	---------	----

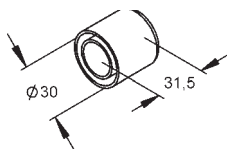

K Eindkap VB 30, gesloten, geel

Eindkap	30	57135	0,01	25 stuk	HA
---------	----	-------	------	---------	----

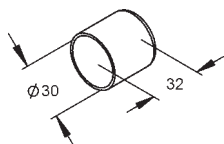

NIEDAX Typenummer	Afmetingen mm H x B	Artikel Nummer		kg stuk/m	VPE	Korting groep
----------------------	---------------------------	-------------------	--	--------------	-----	------------------

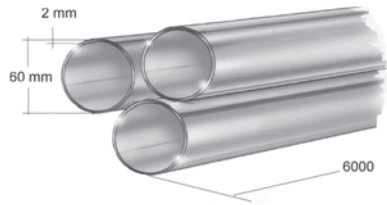

V Kabelbuis VB 60

lengte 6 meter

Kabelbuis	60	69001		2,9	6 m	HA
-----------	----	--------------	--	-----	-----	----

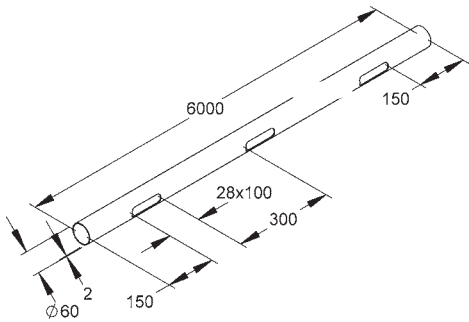

V Kabelbuis VB 60, met kabeldoorvoer

lengte 6 meter

Kabelbuis	60	69003		2,9	6 m	HA
-----------	----	--------------	--	-----	-----	----

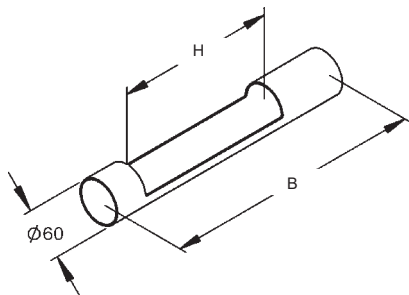

V Kabeluitgang VB 60

Kabeluitgang	120	260	69123	0,62	p/stuk	HA
Kabeluitgang	220	360	69124	0,77	p/stuk	HA
Kabeluitgang	320	460	69125	0,93	p/stuk	HA
Kabeluitgang	420	560	69126	1,08	p/stuk	HA
Kabeluitgang	520	660	69127	1,23	p/stuk	HA

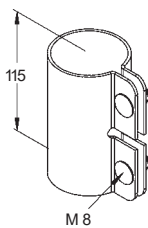

V Koppeling VB 60

Koppeling	60	69107		0,56	p/stuk	HA
-----------	----	--------------	--	------	--------	----

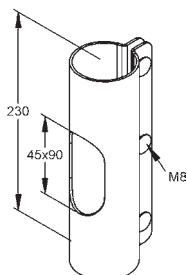

V Koppeling VB 60, met kabeldoorvoer

Koppeling	60	69108		1,07	p/stuk	HA
-----------	----	--------------	--	------	--------	----

NIEDAX Typenummer	Afmetingen mm H x B	Artikel Nummer		kg stuk	VPE	Korting groep
----------------------	---------------------------	-------------------	--	------------	-----	------------------

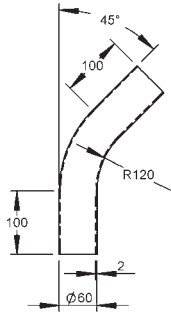

V Bocht 45° VB 60

Bocht 45°	60	69102		0,98	p/stuk	HA
-----------	----	-------	--	------	--------	----

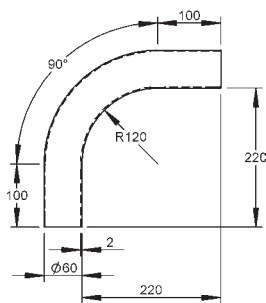

V Bocht 90° VB 60

Bocht 90°	60	69103		1,34	p/stuk	HA
-----------	----	-------	--	------	--------	----

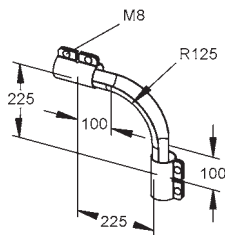

V Open bocht 90° VB 60, R = 125 mm

Open bocht 90°	60	69104		1,34	p/stuk	HA
----------------	----	-------	--	------	--------	----

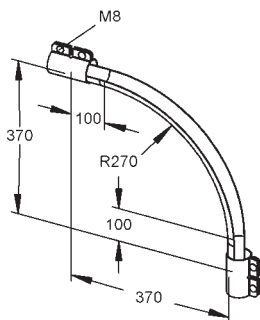

V Open bocht 90° VB 60, R = 270 mm

Open bocht 90°	60	69105		2,4	p/stuk	HA
----------------	----	-------	--	-----	--------	----

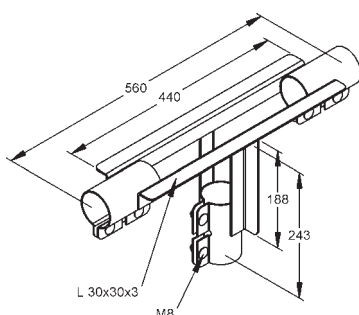

V T-Stuk VB 60

T-Stuk	60	69106		3,52	p/stuk	HA
--------	----	-------	--	------	--------	----

Altube
kabelbuizen

NIEDAX Typenummer	Afmetingen mm H x B	Artikel Nummer		kg stuk	VPE	Korting groep
----------------------	---------------------------	-------------------	--	------------	-----	------------------

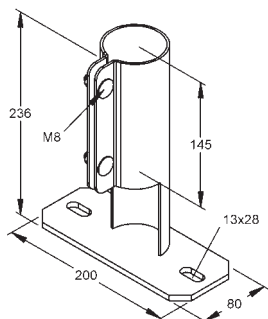

V Vloerbevestiging VB 60

Vloerbevestiging	60	69114		1,65	p/stuk	HA
------------------	----	-------	--	------	--------	----

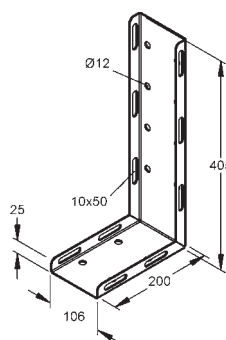

V Grondhoek VB 60 (U-bout niet inbegrepen)

Grondhoek	60	69115		2,05	p/stuk	HA
-----------	----	-------	--	------	--------	----

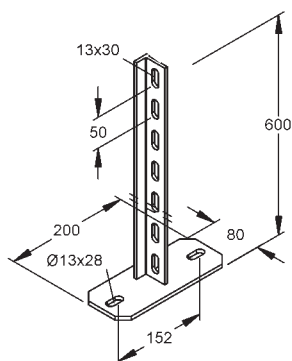

V Vloerplaat Hoek-profiel VB 60

Vloerplaat	60	69122		2,60	p/stuk	HA
------------	----	-------	--	------	--------	----

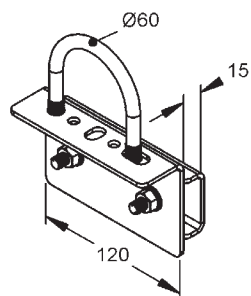

V Bevestiging VB 60 voor C-vorm tot 15 mm, vast

Bevestiging	60	69150		0,64	p/stuk	HA
-------------	----	-------	--	------	--------	----

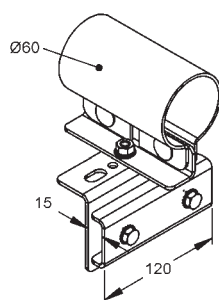

V Bevestiging VB 60 voor C-vorm tot 15 mm, draaibaar

Bevestiging	60	69152		1,81	p/stuk	HA
-------------	----	-------	--	------	--------	----

NIEDAX Typenummer	Afmetingen mm H x B	Artikel Nummer		kg stuk	VPE	Korting groep
----------------------	---------------------------	-------------------	--	------------	-----	------------------

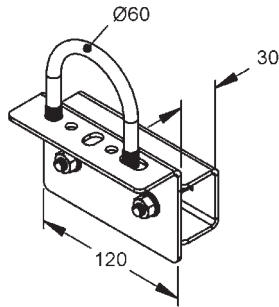

V Bevestiging VB 60 voor C-vorm tot 30 mm, vast

Bevestiging	60	69154		0,73	stuk	HA
-------------	----	-------	--	------	------	----

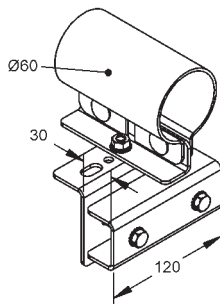

V Bevestiging VB 60 voor C-vorm tot 30 mm, draaibaar

Bevestiging	60	69156		0,73	stuk	HA
-------------	----	-------	--	------	------	----

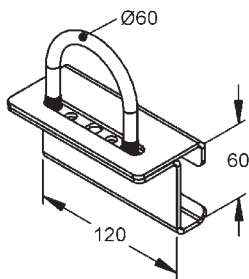

V Bevestiging VB 60 voor koker 20x60 mm, vast

Bev. koker vast	60	69158		0,97	stuk	HA
-----------------	----	-------	--	------	------	----

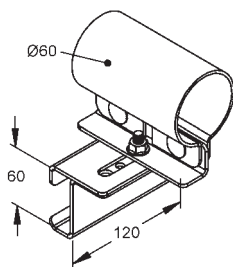

V Bevestiging VB 60 voor koker 20x60 mm, draaibaar

Bev. koker draai.	60	69160		0,97	stuk	HA
-------------------	----	-------	--	------	------	----

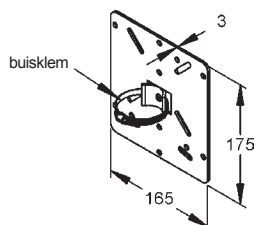

V Montageplaat VB 60, incl. 1 buisklem

Montageplaat	60	69116		0,69	stuk	HA
--------------	----	-------	--	------	------	----

Altube
kabelbuizen

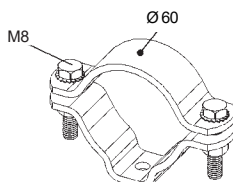
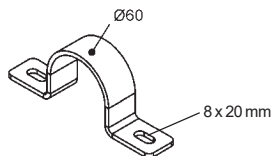
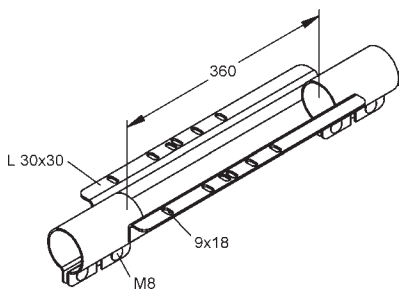
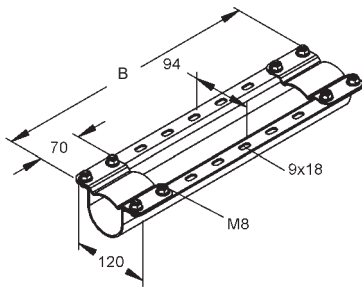
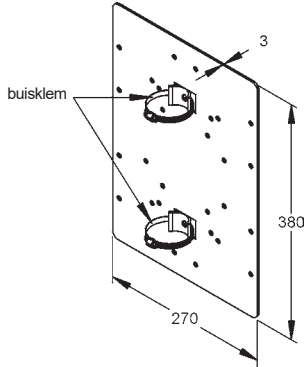
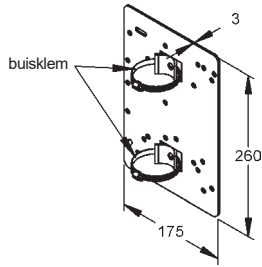

NIEDAX Typenummer	Afmetingen mm H x B	Artikel Nummer		kg stuk	VPE	Korting groep
----------------------	---------------------------	-------------------	--	------------	-----	------------------

V Montageplaat VB 60, incl. 2 buisklemmen

Montageplaat	60	69117		1,13	p/stuk	HA
--------------	----	--------------	--	------	--------	----

V Montageplaat VB 60, incl. 2 buisklemmen

Montageplaat	60	69118		2,57	p/stuk	HA
--------------	----	--------------	--	------	--------	----

V Montage-unit VB 60, gesloten

Montage-unit	325	69170		1,81	p/stuk	HA
Montage-unit	400	69171		2,23	p/stuk	HA
Montage-unit	500	69172		2,65	p/stuk	HA
Montage-unit	600	69173		3,06	p/stuk	HA

V Montage-unit VB 60, open

Montage-unit	60	69120		2,3	p/stuk	HA
--------------	----	--------------	--	-----	--------	----

V Buisbeugel VB 60

Buisbeugel	60	69121		0,22	20 stuk	HA
------------	----	--------------	--	------	---------	----

V Muur - draadpendelbevestiging VB 60

Pijbeugel	60	69144		0,31	20 stuk	HA
-----------	----	--------------	--	------	---------	----

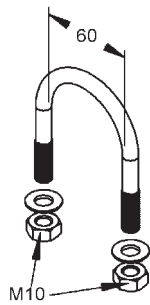

NIEDAX Typenummer	Afmetingen mm H x B	Artikel Nummer		kg stuk/m	VPE	Korting groep
----------------------	---------------------------	-------------------	--	--------------	-----	------------------

V U-bout VB 60 met 2 x ring en moer

U-bout	60	69142		0,11	20 stuk	HA
--------	----	-------	--	------	---------	----

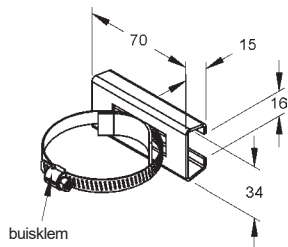

V Buisklem VB 60 met profiel

Buisklem	60	69131		0,08	p/stuk	HA
----------	----	-------	--	------	--------	----

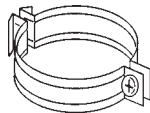

V Pijpbeugel VB 60

VR CR 60-3		45120		0,06	p/stuk	HA
------------	--	-------	--	------	--------	----

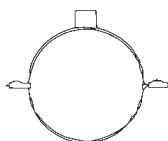

E Draadpendelbevestiging EB 60

Draadpendelbev.	M8+M10	69146		0,09	p/stuk	HA
-----------------	--------	-------	--	------	--------	----

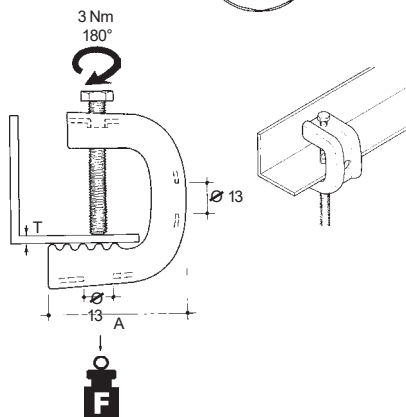

V Balkklem

Balkklem C 20	3-20 mm	45101		0,11	p/stuk	HA
Balkklem C 30	3-30 mm	45102		0,13	p/stuk	HA
Balkklem C 45	3-45 mm	45103		0,16	p/stuk	HA

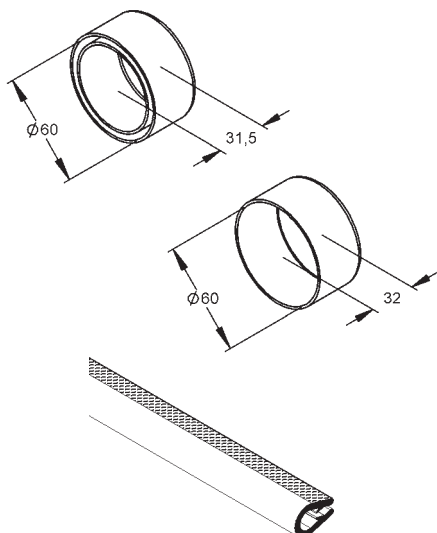

K Eindkap VB 60, open, geel

Eindkap	60	69133		0,01	25 stuk	HA
---------	----	-------	--	------	---------	----

K Eindkap VB 60, gesloten, geel

Eindkap	60	69135		0,01	25 stuk	HA
---------	----	-------	--	------	---------	----

K Beschermstrip VB

Beschermstrip	5x10	69137		0,08	m	HA
Beschermstrip	10x16	69136		0,10	m	HA

Altube
kabelbuizen

Roestvast stalen buizen

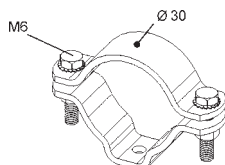
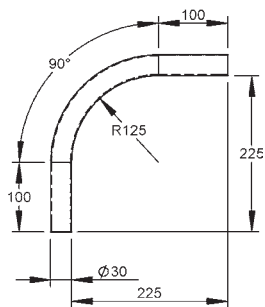
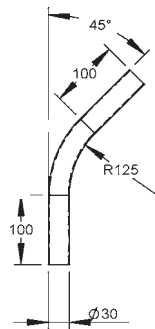
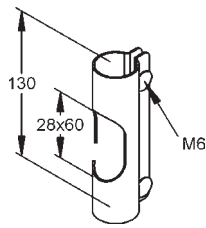
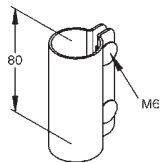
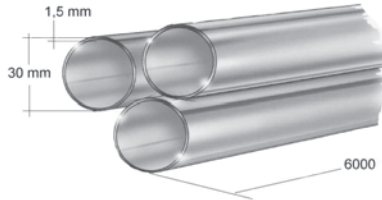

NIEDAX Typenummer	Afmetingen mm H x B	Artikel Nummer	kg stuk/m	VPE	Korting groep
----------------------	---------------------------	-------------------	--------------	-----	------------------

R2 Kabelbuis R2 B30

lengte 6 meter

Kabelbuis	30	56001	1,19	6 m	HA
-----------	----	-------	------	-----	----

R2 Koppeling R2 B30

Koppeling	30	56107	0,12	p/stuk	HA
-----------	----	-------	------	--------	----

R2 Koppeling R2 B30, met kabeldoorvoer

Koppeling	30	56108	0,17	p/stuk	HA
-----------	----	-------	------	--------	----

R2 Bocht 45° R2 B30

Bocht 45°	30	56102	0,35	p/stuk	HA
-----------	----	-------	------	--------	----

R2 Bocht 90° R2 B30

Bocht 90°	30	56103	0,35	p/stuk	HA
-----------	----	-------	------	--------	----

R2 Muur - draadpendelbevestiging R2 B30

Pijpbeugel	30	56144	0,1	p/stuk	HA
------------	----	-------	-----	--------	----

NIEDAX Typenummer	Afmetingen mm H x B	Artikel Nummer		kg stuk	VPE	Korting groep
----------------------	---------------------------	-------------------	--	------------	-----	------------------

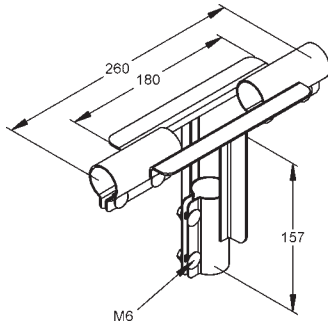

R2 T-Stuk R2 B30

T-Stuk	30	56106		0,67	p/stuk	HA
--------	----	-------	--	------	--------	----

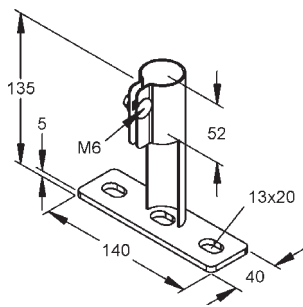

R2 Vloerbevestiging R2 B30

Vloerbevestiging	30	56114		0,36	p/stuk	HA
------------------	----	-------	--	------	--------	----

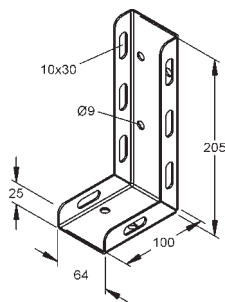

R2 Grondhoek R2 B30 (U-bout niet inbegrepen)

Grondhoek	30	56115		0,48	p/stuk	HA
-----------	----	-------	--	------	--------	----

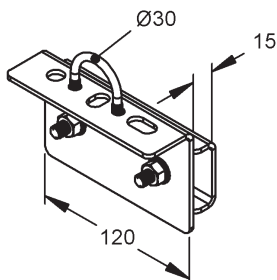

R2 Bevestiging R2 B30 voor C-vorm tot 15 mm, vast

Bevestiging	30	56150		0,55	p/stuk	HA
-------------	----	-------	--	------	--------	----

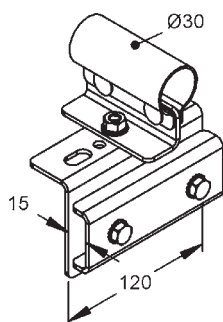

R2 Bevestiging R2 B30 voor C-vorm tot 15 mm, draaibaar

Bevestiging	30	56152		1,31	p/stuk	HA
-------------	----	-------	--	------	--------	----

Altube
kabelbuizen

R2

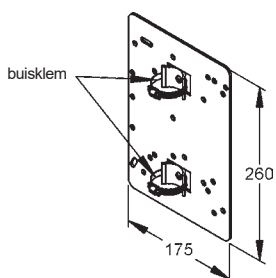
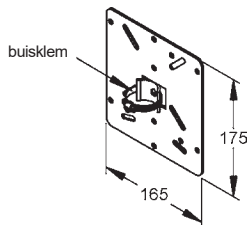
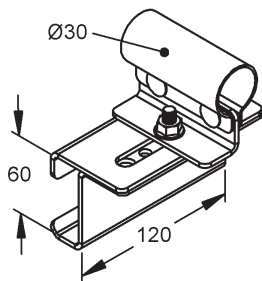
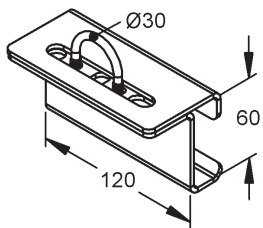
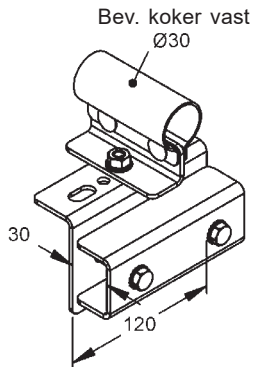
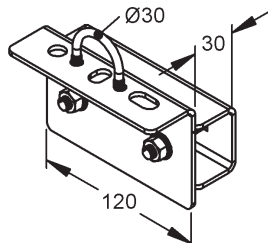

NIEDAX Typenummer	Afmetingen mm H x B	Artikel Nummer	kg stuk	VPE	Korting groep
----------------------	---------------------------	-------------------	------------	-----	------------------

R2 Bevestiging R2 B30 voor C-vorm tot 30 mm, vast

Bevestiging	30	56154	0,64	p/stuk	HA
-------------	----	-------	------	--------	----

R2 Bevestiging R2 B30 voor C-vorm tot 30 mm, draaibaar

Bevestiging	30	56156	1,41	p/stuk	HA
-------------	----	-------	------	--------	----

R2 Bevestiging R2 B30 voor koker 20x60 mm, vast

Bev. koker vast	30	56158	0,88	p/stuk	HA
-----------------	----	-------	------	--------	----

R2 Bevestiging R2 B30 voor koker 20x60 mm, draaibaar

Bev. koker draai.	30	56160	0,8	p/stuk	HA
-------------------	----	-------	-----	--------	----

R2 Montageplaat R2 B30, incl. 1 buisklem

Montageplaat	30	56116	0,69	p/stuk	HA
--------------	----	-------	------	--------	----

R2 Montageplaat R2 B30, incl. 2 buisklemmen

Montageplaat	30	56117	1,13	p/stuk	HA
--------------	----	-------	------	--------	----

NIEDAX Typenummer	Afmetingen mm H x B	Artikel Nummer	kg stuk	VPE	Korting groep
----------------------	---------------------------	-------------------	------------	-----	------------------

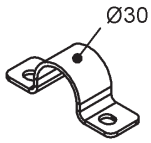

R2 Buisbeugel R2 B30

Buisbeugel	30	56121	0,06	20 stuk	HA
------------	----	-------	------	---------	----

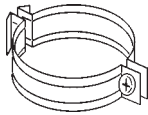

R2 Pijpbeugel R2 B30

R2CR28-2	30	45118	0,05	p/stuk	HA
----------	----	-------	------	--------	----

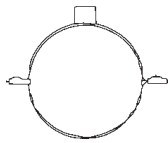

R4 Draadpendelbevestiging R4B30

Draadpendelbev.	M8	56146	0,06	p/stuk	HA
-----------------	----	-------	------	--------	----

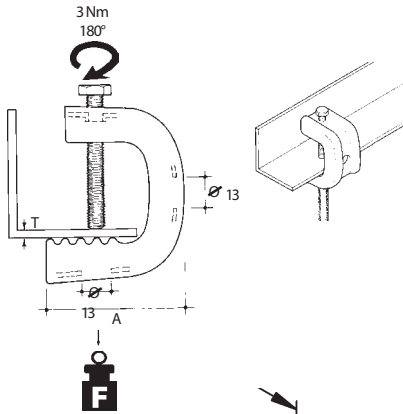

R2 Balkklem

Balkklem C 20	3-20 mm	81621	0,11	p/stuk	HA
Balkklem C 30	3-30 mm	81622	0,17	p/stuk	HA

R2 U-bout R2 B30 met 2 x ring en moer

U-bout	30	56130	0,03	20 stuk	HA
--------	----	-------	------	---------	----

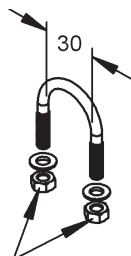

R2 Buisklem R2 B30 met profiel

Buisklem	30	56131	0,08	p/stuk	HA
----------	----	-------	------	--------	----

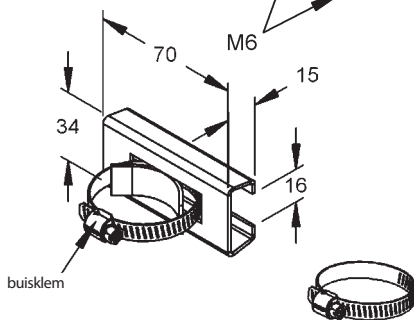

R2 Buisklem R2 B30

Buisklem	30	69140	0,02	50 stuk	HA
----------	----	-------	------	---------	----

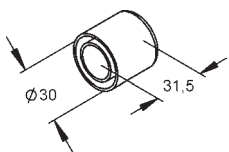

K Eindkap VB 30, open, geel

Eindkap	30	57133	0,01	25 stuk	HA
---------	----	-------	------	---------	----

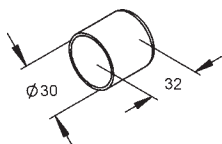

K Eindkap VB 30, gesloten, geel

Eindkap	30	57135	0,01	25 stuk	HA
---------	----	-------	------	---------	----

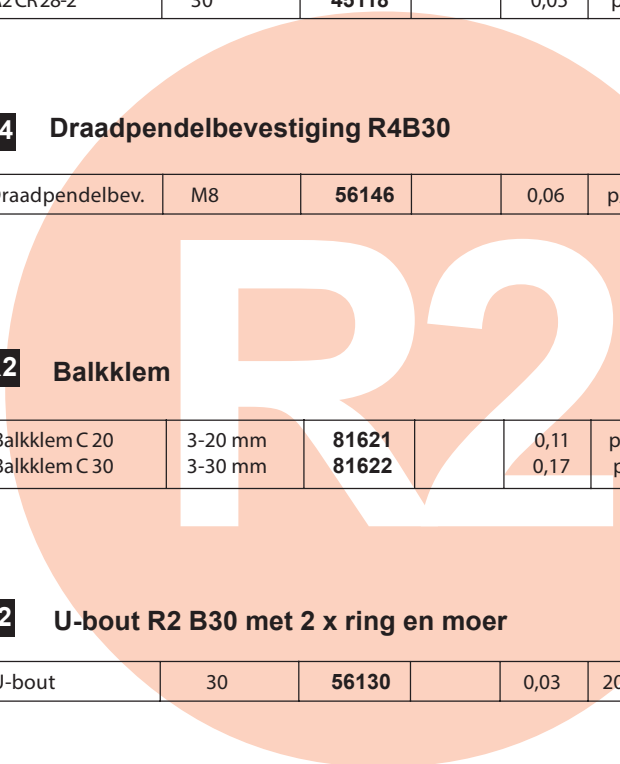

NIEDAX Typenummer	Afmetingen mm H x B	Artikel Nummer		 stuk/m	 VPE	Korting groep
----------------------	---------------------------	-------------------	--	---	--	------------------

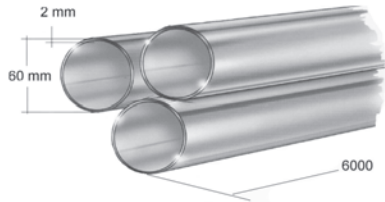

R2 Kabelbuis R2 B60

lengte 6 meter

Kabelbuis	60	68001		2,9	6 m	HA
-----------	----	--------------	--	-----	-----	----

R2 Kabeluitgang R2 B60

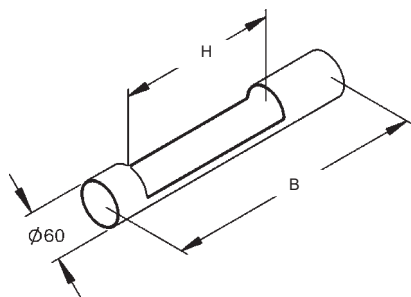

Kabeluitgang	120	260	68123	0,65	p/stuk	HA
Kabeluitgang	220	360	68124	0,80	p/stuk	HA
Kabeluitgang	320	460	68125	0,95	p/stuk	HA
Kabeluitgang	420	560	68126	1,10	p/stuk	HA
Kabeluitgang	520	660	68127	1,25	p/stuk	HA
Kabeluitgang	720	860	68128	1,55	p/stuk	HA

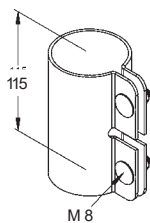

R2 Koppeling R2 B60

Koppeling	60	68107		0,56	p/stuk	HA
-----------	----	--------------	--	------	--------	----

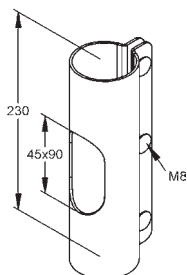

R2 Koppeling R2 B60, met kabeldoorvoer

Koppeling	60	68108		1,07	p/stuk	HA
-----------	----	--------------	--	------	--------	----

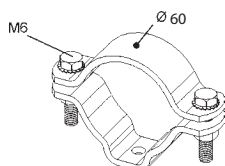

R2 Muur - draappendelbevestiging R2B60

Pijpbeugel	60	68144		0,31	p/stuk	HA
------------	----	--------------	--	------	--------	----

NIEDAX Typenummer	Afmetingen mm H x B	Artikel Nummer		kg stuk	VPE	Korting groep
----------------------	---------------------------	-------------------	--	------------	-----	------------------

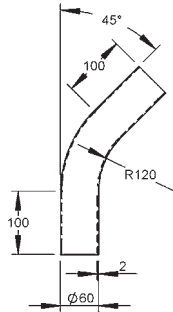

R2 Bocht 45° R2 B60

Bocht 45°	60	68102		0,98	p/stuk	HA
-----------	----	-------	--	------	--------	----

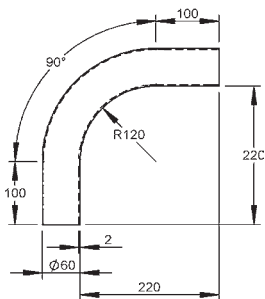

R2 Bocht 90° R2 B60

Bocht 90°	60	68103		1,34	p/stuk	HA
-----------	----	-------	--	------	--------	----

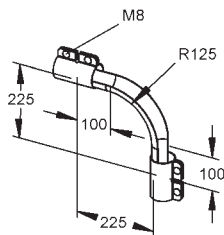

R2 Open bocht 90° R2 B60, R = 125 mm

Open bocht 90°	60	68104		1,34	p/stuk	HA
----------------	----	-------	--	------	--------	----

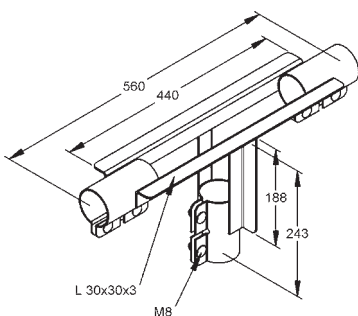

R2 T-Stuk R2 B60

T-Stuk	60	68106		3,52	p/stuk	HA
--------	----	-------	--	------	--------	----

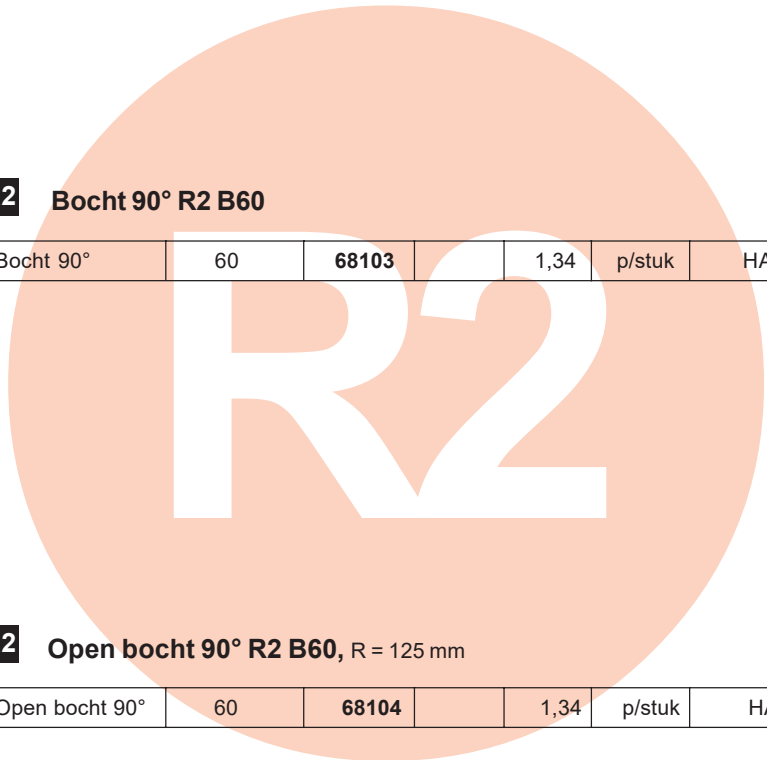

NIEDAX Typenummer	Afmetingen mm H x B	Artikel Nummer		 kg stuk	 VPE	Korting groep
-----------------------------	---------------------------	---------------------------	--	---	--	------------------

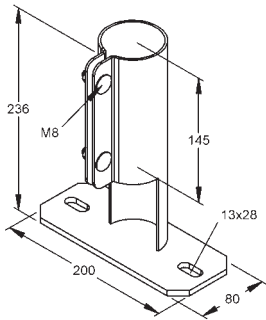

R2 Vloerbevestiging R2 B60

Vloerbevestiging	60	68114		1,65	p/stuk	HA
------------------	----	--------------	--	------	--------	----

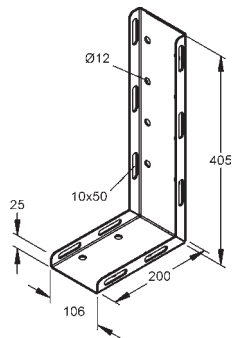

R2 Grondhoek R2 B60 (U-bout niet inbegrepen)

Grondhoek	60	68115		2,05	p/stuk	HA
-----------	----	--------------	--	------	--------	----

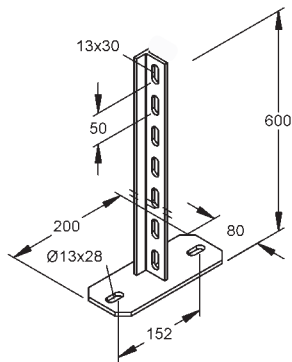

R2 Vloerplaat Hoek-profiel R2 B60

Vloerplaat	60	68122		2,6	p/stuk	HA
------------	----	--------------	--	-----	--------	----

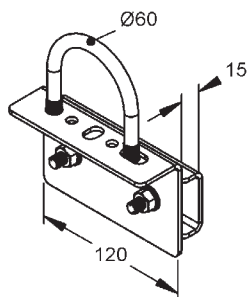

R2 Bevestiging R2 B60 voor C-vorm tot 15 mm, vast

Bevestiging	60	68150		0,64	p/stuk	HA
-------------	----	--------------	--	------	--------	----

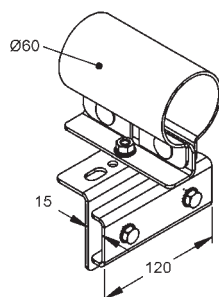

R2 Bevestiging voor C-vorm tot 15 mm, draaibaar

Bevestiging	60	68152		1,81	p/stuk	HA
-------------	----	--------------	--	------	--------	----

NIEDAX Typenummer	Afmetingen mm H x B	Artikel Nummer		kg stuk	VPE	Korting groep
----------------------	---------------------------	-------------------	--	------------	-----	------------------

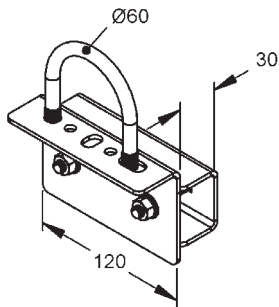

R2 Bevestiging R2 B60 voor C-vorm tot 30 mm, vast

Bevestiging	60	68154		0,73	p/stuk	HA
-------------	----	-------	--	------	--------	----

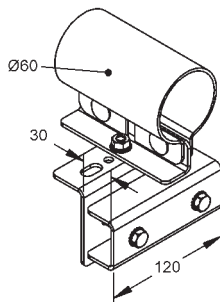

R2 Bevestiging R2 B60 voor C-vorm tot 30 mm, draaibaar

Bevestiging	60	68156		0,73	p/stuk	HA
-------------	----	-------	--	------	--------	----

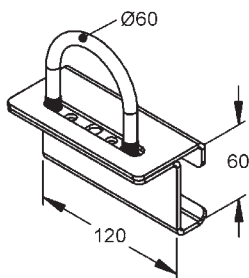

R2 Bevestiging R2 B60 voor koker 20x60 mm, vast

Bev. koker vast	60	68158		0,97	p/stuk	HA
-----------------	----	-------	--	------	--------	----

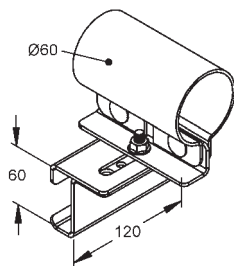

R2 Bevestiging R2 B60 voor koker 20x60 mm, draaibaar

Bev. koker draai.	60	68160		0,97	p/stuk	HA
-------------------	----	-------	--	------	--------	----

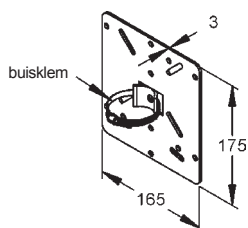

R2 Montageplaat R2 B60, incl. 1 buisklem

Montageplaat	60	68116		0,69	p/stuk	HA
--------------	----	-------	--	------	--------	----

Altube
kabelbuizen

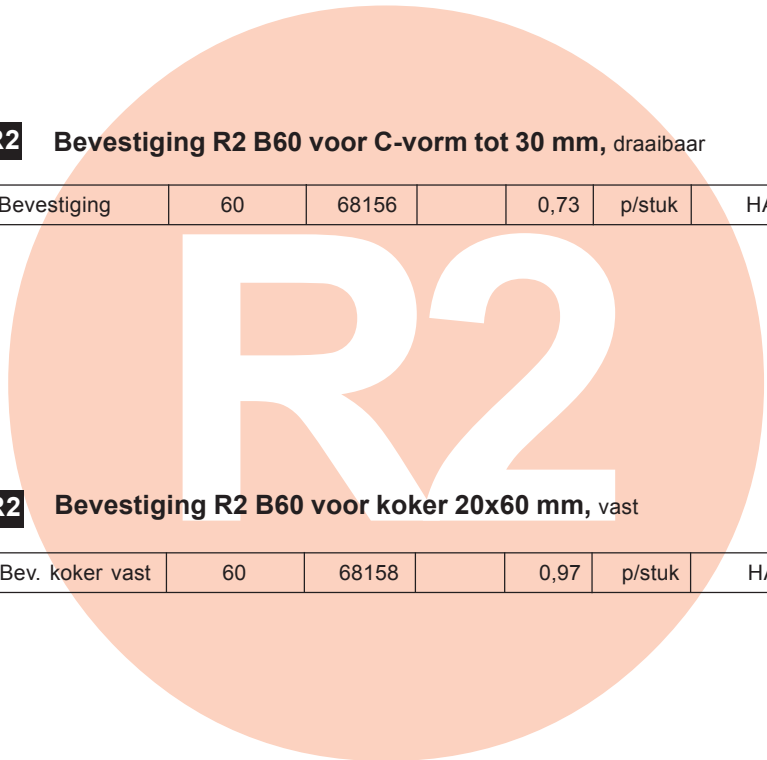

NIEDAX Typenummer	Afmetingen mm H x B	Artikel Nummer		kg stuk	VPE	Korting groep
----------------------	---------------------------	-------------------	--	------------	-----	------------------

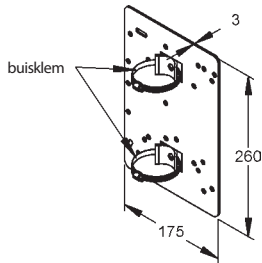

R2 Montageplaat R2 B60, incl. 2 buisklemmen

Montageplaat	60	68117		1,13	p/stuk	HA
--------------	----	-------	--	------	--------	----

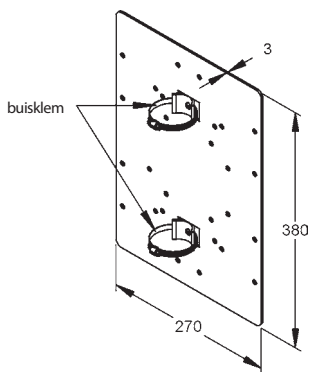

R2 Montageplaat R2 B60, incl. 2 buisklemmen

Montageplaat	60	68118		2,57	p/stuk	HA
--------------	----	-------	--	------	--------	----

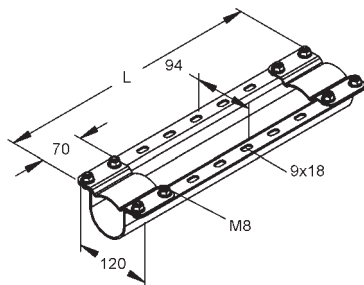

R2 Montage-unit R2 B60, gesloten

Montage-unit	Lengte 325	68119		2,57	p/stuk	HA
--------------	------------	-------	--	------	--------	----

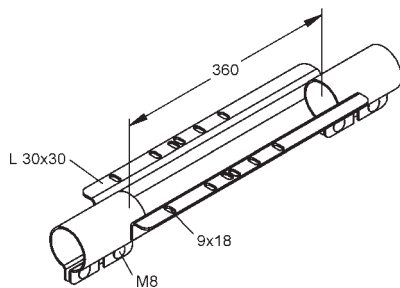

R2 Montage-unit R2 B60, open

Montage-unit	60	68120		2,3	p/stuk	HA
--------------	----	-------	--	-----	--------	----

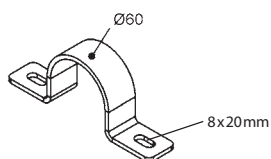

R2 Buisbeugel R2 B60

Buisbeugel	60	68121		0,22	20 stuk	HA
------------	----	-------	--	------	---------	----

NIEDAX Typenummer	Afmetingen mm H x B	Artikel Nummer		kg stuk	VPE	Korting groep
----------------------	---------------------------	-------------------	--	------------	-----	------------------

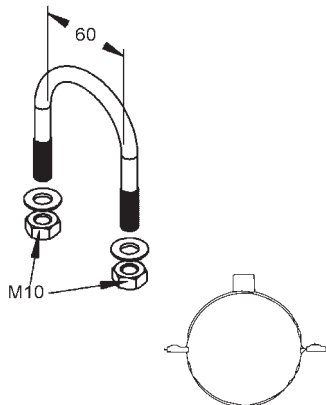

R2 U-bout R2 B60 met 2 x ring en moer

U-bout	60	68130		0,11	20 stuk	HA
--------	----	-------	--	------	---------	----

R4 Draadpendelbevestiging R4B60

Draadpendelbev.	M8	68146		0,09	p/stuk	HA
-----------------	----	-------	--	------	--------	----

R2 Pijpbeugel R2B 60

R2 CR 60-2		45119		0,06	p/stuk	HA
------------	--	-------	--	------	--------	----

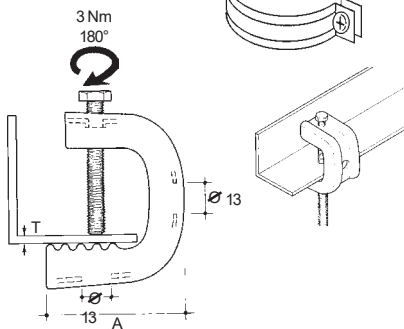

R2 Balkklem

Flensdikte

Balkklem C 20	4-20 mm	81621		0,11	p/stuk	HA
Balkklem C 30	17-30 mm	81622		0,17	p/stuk	HA

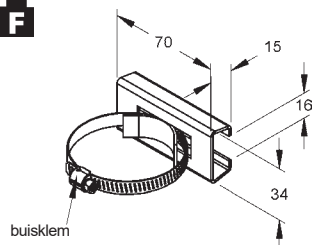

R2 Buisklem R2 B60 met profiel

Buisklem	60	68131		0,08	p/stuk	HA
----------	----	-------	--	------	--------	----



R2 Buisklem R2 B60

Buisklem	Ø60 x 9	69139		0,02	50 stuk	HA
Buisklem	Ø60 x 12	69132		0,02	50 stuk	HA

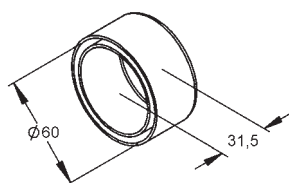

K Eindkap VB 60, open, geel

Eindkap	60	69133		0,01	25 stuk	HA
---------	----	-------	--	------	---------	----

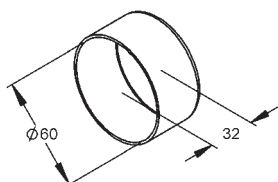

K Eindkap VB 60, gesloten, geel

Eindkap	60	69135		0,01	25 stuk	HA
---------	----	-------	--	------	---------	----

Leveringsvoorwaarden

Algemene leverings- en betalingsvoorwaarden van de besloten vennootschap Niedax Kleinhuis te Wijchen gedeponereerd ter griffie van de Arrondissementsrechtbank te Arnhem op 7 september 1987 onder nummer 2518/1987

Toepasselijkheid

De onderstaande leveringsvoorwaarden zijn van toepassing op al onze transacties. Afwijkingen van deze voorwaarden binden ons alleen indien deze vooraf door ons schriftelijk zijn bevestigd. Behoudens schriftelijke en uitdrukkelijke overeenkomst in andere zin binden inkoopvoorwaarden van afnemers ons niet.

Offerte

Alle offertes zijn vrijblijvend. Afbeeldingen, tekeningen, gewichten, afmetingen e.d. gelden slechts bij benadering, tenzij onzerzijds schriftelijk en uitdrukkelijk een garantie wordt verstrekt.

Prijzen

Onze prijzen zijn exclusief omzetbelasting, en uitgedrukt in Euro's. Wij behouden ons steeds het recht voor onze prijslijsten te wijzigen.

Kwaliteit en garantie

Wegens de levering van de goederen staan wij tegenover onze afnemers in voor de kwaliteitsnormen, welke vermeld worden in onze documentatie. Wij behouden ons het recht voor deze gegevens zonder voorafgaande mededeling te wijzigen. Overigens verstrekken wij geen verdere garantie, dan die welke onze eigen leverancier tegenover onszelf op zich neemt, tenzij van het tegendeel blijkt uit een door ons afgegeven schriftelijke garantieverklaring.

Levering

Goederen worden binnen Nederland franco geleverd. Op orders, met een lagere waarde dan € 170,- netto wordt een kostentoeslag berekend van € 14,-. Extra kosten van verzendingen, welke op verzoek van de afnemer per expresse of naar meerdere adressen worden verzonden, brengen wij in rekening. Verpakking is inclusief. Pallets en palletranden worden in rekening gebracht en na franco-retourzending volledig gecrediteerd.

De door ons opgegeven levertijden gelden slechts bij benadering, tenzij een bepaalde leveringstermijn schriftelijk uitdrukkelijk is gegarandeerd. Overschrijding van bedoelde levertijden, door welke oorzaak ook, verplicht ons niet tot schadevergoeding, en geeft onze afnemer evenmin het recht tot ontbinding. Bij levering in gedeelten hebben wij het recht van betaling van eerdere deellieferingen te verlangen alvorens verdere leveringen te verrichten. Wij zijn niet gehouden overcomplete materialen retour te nemen. Retour te nemen goederen moeten in originele en onbeschadigde staat verkeren, en franco aan ons worden toegezonden. Accepteren wij de retourzending, dan wordt de gefactureerde waarde gecrediteerd onder aftrek van 10 % van het bruto bedrag. Speciaal behandelde of gefabriceerde materialen, danwel incurante materialen, kunnen nooit worden teruggenomen.

Eigendomsvoorbehoud.

Wij behouden ons de eigendom voor van alle door ons geleverde goederen totdat de afnemer aan al zijn financiële verplichtingen jegens ons zal hebben voldaan, waaronder de betaling van de geleverde goederen met eventuele rente en kosten. Het is de afnemer niet toegestaan de goederen te verpanden, in eigendom tot zekerheid over te dragen, of aan andere ter zake deze goederen rechten te verlenen. Indien de afnemer niet aan zijn verplichtingen jegens ons voldoet, zijn wij steeds bevoegd door ons geleverde goederen als ons eigendom terug te nemen, ongeacht waar zij zich bevinden.

Annulering

Bij overmacht of andere omstandigheden van zodanige aard, dat naar redelijkheid nakoming niet van ons kan worden geleverd, daaronder mede begrepen het geval, dat wij door onze eigen leveranciers, ongeacht de reden daartoe, niet tot levering in staat worden gesteld, zal de leveringsplicht worden opgeschort, en de levertijd worden verlengd met een tijdsduur gelijk aan die van het voortduren van die omstandigheden. Mocht de verlenging langer duren dan drie maanden dan zijn wij bevoegd de transactie voor het nog niet uitgevoerde deel geheel of gedeeltelijk te annuleren zonder tot enige vergoeding gehouden te zijn. In geval van gedeeltelijke annulering zal een corresponderend deel van de prijs door de afnemer verschuldigd zijn.

Betalingen

Betalingen dienen te geschieden binnen 30 dagen na factuurdatum, netto. Wij behouden ons het recht voor voorafgaande betaling of levering onder rembours te verlangen. Bij niet tijdige algehele betaling van de factuurbedragen binnen de overeengekomen betalingstermijn zullen wij steeds bevoegd zijn zonder nadere sommatie of ingebrekestelling de overeenkomst ontbonden te verklaren zonder dat rechtelijke tussenkomst zal zijn vereist, en ongeacht ons recht schadevergoeding te vorderen. Na het verstrijken van de betalingstermijn zijn wij gerechtigd 1 % verdragingsrente per maand in rekening te brengen. Alle kosten welke wij tot behoud van onze rechten dienstig mochten oordelen, zowel gerechtelijk als buitengerechtelijk, komen voor rekening van de afnemer, waarbij de buitengerechtelijke incassokosten worden gefixeerd op 10 % van het restant verschuldigd met een minimum van € 45,-. Wij behouden ons het recht voor met het oog op reeds geleverde of alsnog te leveren goederen zekerheid te verlangen voor de tijdige betaling van de koopsom in de vorm van vooruitbetaling, bankgarantie, borgtocht of eigendomsoverdracht tot zekerheid.

Reclames

Reclames worden alleen geaccepteerd, als zij binnen acht dagen na aflevering van de goederen schriftelijk kenbaar worden gemaakt. Het indienen van reclames ontheft niet van de verplichting tot betaling van de overeengekomen koopsom.

Geschillen

Alle geschillen zullen, naar onze keuze, worden berecht door de Arrondissementsrechtbank te Arnhem, dan wel de bevoegde rechter in de woonplaats van de afnemer.